

Vet BP



SUNTECH

Vet30



Continuous Vital Signs Monitor for Companion Animals

User Manual

Changes

This manual is identified as part number: 80-0075-00-RevK. This manual is for use with Vet30 models M30A and M30B. An updated version may be available for download from the SunTech Medical website. Should you notice errors or omissions in this manual, please notify us at:

SunTech Medical, Inc.

5827 S Miami Blvd, Suite 100

Morrisville, NC 27560 USA

Tel: 800.421.8626

919.654.2300

Fax: 919.654.2301

Email: CustomerSupport@SunTechMed.com

Web: www.SunTechMed.com

Copyright Information

All content in this manual is the proprietary information of SunTech Medical and is provided solely for purposes of operation of the SunTech Vet30. This manual and the Vet30 described in it are protected under copyright law under which they may not be copied, in whole or in part, without written consent of SunTech Medical.

The information in this manual is furnished for guidance only, is subject to change without notice, and should not be construed as a commitment by SunTech Medical. SunTech Medical assumes no liability for errors or inaccuracies that may appear in this manual.

© 2022 SunTech Medical. All rights reserved.



SunTech Medical, Inc.
5827 S Miami Blvd, Suite 100
Morrisville, NC 27560-8394
Phone: 1-919-654-2300
1-800-421-8626
Fax: 1-919-654-2301

Other office location:

SunTech Medical (Shenzhen) Co., Ltd.
105 HuanGuan South Road, Suite 15 2~3/F
DaHe Community Guanlan,
LongHua District, Shenzhen
GuangDong PRC 518110
Tel: + 86-755-29588810
+ 86-755-29588986 (Sales)
+ 86-755-29588665 (Service)
Fax: + 86-755-29588829

Welcome to the SunTech Vet30

Thank you for choosing the Vet30 vital signs monitor! For over 30 years, SunTech Medical has been the preeminent supplier of leading edge technology and innovative products to obtain blood pressure (BP) measurements. Developed specifically for the veterinary care environment, the Vet30 can perform automatic BP, pulse oximetry (SpO₂), and body temperature measurements for veterinary professionals.

For measuring BP, a BP cuff is placed around the patient's forelimb or tail. The cuff is inflated automatically and blood pressure is determined by the oscillometric method, which senses pressure waves in the artery when occluded by pressure in the cuff. Measurement of the frequency of the pressure waves enables heart rate to also be measured.

The pulse oximetry function measures the patient's percent functional oxygen saturation of arterial hemoglobin using principles of plethysmography via a SpO₂ sensor placed on the patient. Arterial oxyhemoglobin saturation is determined by measuring the absorption of red and infrared light passing through the tissue. Changes in absorption caused by pulsations of blood in the vascular bed are used to determine arterial saturation and pulse rate. The Vet30 provides two options for SpO₂: AccuVet™ or Masimo™ SET®. The oximeters require no routine calibration or maintenance. The display features a pulse oximetry focus screen, which displays the SpO₂ plethysmograph. The waveform is not normalized.

Temperature can be measured using a temperature probe. The temperature probe contains a thermistor that generates a voltage based on changes in temperature, and these voltages are recorded by the temperature circuitry.

The Vet30 is a portable device, weighing approximately 2.65 lb (1202 g). Control buttons allow the user to turn on or off the device and stop/start a BP measurement. The touchscreen display shows the device status and measurement information, and allows for selection of settings. The device uses a microprocessor with software, which is not accessible to the user. The unit is powered by a single rechargeable lithium-ion battery at the bottom of the device. Bluetooth can be used to wirelessly connect and send data to a PC application, which may be downloaded from the SunTech website at: <https://www.suntechmed.com/vet30-data-capture>. Upper and lower alarm limits can be set for all parameters.

Intended Use

The SunTech Vet30 and Vet25 monitors are clinical grade automated blood pressure measurement devices that provide oscillometric non-invasive blood pressure. The Vet30 provides additional pulse oximetry and temperature measurement capabilities. These portable devices are for use in the veterinary clinic on companion animals (cats and dogs). The devices can be used for spot-check or continuous monitoring activities. They are not intended for human use.

The devices are contraindicated for use on humans or any species other than those described above.

Vet30 Essential Performance:

The Essential Performance of the Vet30 models are designed to measure, record, and display a patient's blood pressure within a blood pressure accuracy range of +/- 5 mmHg mean error & 8mm Hg standard deviation (*max inflate 280 mmHg*).

Additionally, these models are designed to measure, record, and display a patient's functional oxygen saturation over the range of 70% to 100% with an increment of 1% within an accuracy of +/- 3%. These models shall also measure, record, and display a patient's continuous temperature within an accuracy of no greater than 0.3°C (+/- 3 digits) when used with a minimum temperature range of 26°C to 46°C.

User Responsibility

The Vet30 is designed to perform in conformity with the description thereof contained in this operation manual when operated. This operation manual is for use with Vet30 models M30A and M30B. The user of this monitor shall have the sole responsibility for any malfunction which results from improper use, faulty maintenance, improper repair, damage or alteration by anyone other than SunTech Medical or their authorized service personnel. The Vet30 is for use only by or on the direction of a licensed veterinarian.

Use of Vet30

Use only veterinary BP cuffs supplied by SunTech Medical. Observe the patient carefully during the measurement. Accuracy of any BP reading or oxygen saturation measurement may be affected by the position of the patient, their physical condition and use outside of the operating instructions detailed in this guide. The interpretation of BP and oxygen saturation measurements should only be made by a veterinarian.

AccuVet SpO₂ Module: Use only AccuVet SpO₂ sensors supplied by SunTech Medical.

Masimo SET SpO₂ Module: Use only original Masimo SpO₂ sensors and cables.

Check the application site of the SpO₂ sensor frequently to confirm proper positioning of the sensor and to check the circulation and skin sensitivity of the patient.

Table of Contents

Changes.....	2
Copyright Information.....	2
Welcome to the SunTech Vet30.....	3
Intended Use.....	3
1. Warnings and Precautions.....	6
2. Icons and Symbols.....	8
3. Getting to Know SunTech Vet30.....	10
3.1 Applied Parts and Patient Environment.....	10
3.2 Device Placement.....	10
3.3 Front Panel.....	11
3.4 Connect Power, Hose, and Sensors.....	11
3.5 Display.....	14
3.6 Start/Stop Button.....	16
4. Selecting Your Settings.....	16
4.1 Animal Mode.....	16
4.2 Volume.....	16
4.3 Settings.....	16
5. Blood Pressure Measurement.....	21
5.1 Cuff Sizing.....	21
5.2 Where to Apply the Cuff.....	21
5.3 Taking a BP Measurement.....	22
5.4 Interval BP Mode.....	22
5.5 STAT Mode.....	23
5.6 Interrupting/Stopping a Measurement.....	23
5.7 Heart Rate Measurement.....	23
6. Temperature Measurement.....	23
6.1 Where to Apply the Temperature Probe.....	23
6.2 Taking a Temperature Measurement.....	24
7. SpO₂ Measurement.....	24
7.1 Masimo Pulse Oximetry.....	25
7.2 AccuVet Pulse Oximetry.....	27
7.3 Heart Rate Measurement.....	29
8. Reviewing and Transferring Data.....	29
8.1 Viewing Stored Measurements.....	29
8.2 Averaging Measurements.....	30
8.3 Bluetooth Connection.....	30
8.4 Data Transfer.....	31
8.5 Reviewing Data and Creating Reports.....	31
9. Alarms.....	33
9.1 Technical Alarms.....	33
9.2 Clinical Alarms.....	33
10. Taking Care of the SunTech Vet30.....	34
10.1 Battery.....	34
10.2 Cleaning.....	34
10.3 Preventative Maintenance.....	35
10.4 System Components.....	36
10.5 Accessories & Replacement Parts.....	37
10.6 Status Messages.....	38
11. Frequently Asked Questions.....	40
12. Limited Warranty.....	41
13. Technical Information.....	41

13.1 Monitor Model Numbers.....	41
13.2 Factory Default Settings.....	42
13.3 Performance Specifications.....	43
13.4 Radio Frequency Compliance Requirements.....	44
13.5 Electromagnetic Compatibility (EMC).....	44
Appendix A: Service Screens.....	49
Service Information.....	50
Calibration Check.....	50
Air Leak Check.....	51
Restore Factory Defaults.....	52
Software Update.....	52

1. Warnings and Precautions

General warnings and cautions are listed here and repeated where relevant throughout this guide.

A WARNING indicates a situation which, if not avoided, could result in serious injury or death.



WARNING: DO NOT connect patient hose or monitor to any other devices or connections, especially intravenous (IV) tubes as there is potential for air to be pumped into a blood vessel which could cause serious injury.

WARNING: DO NOT use in the presence of flammable anesthetics; this could cause an explosion. This device is not suitable for use in an oxygen enriched environment.

WARNING: This monitor may cause radio interference or may disrupt the operation of nearby equipment. It may be necessary to take mitigation measures such as re-orienting, relocating or shielding the location.

WARNING: The cuff should not be applied over a wound as this can cause further injury.

WARNING: DO NOT use a defibrillator, full body irradiation, or ultrasonic device on the patient at the same time as it may affect the operation and/or safety of the patient due to interactions.

WARNING: DO NOT immerse the monitor in any fluid or attempt to clean the unit with liquid detergents, cleaning agents, or solvents. This may cause an electrical hazard. Do not use the monitor if accidental wetting occurs. Refer to the cleaning section of this guide for instructions on cleaning.

WARNING: Check the limb frequently to ensure that operation of the monitor does not result in prolonged impairment of the circulation of the patient.

WARNING: DO NOT apply the BP cuff to a limb being used for IV infusions or any other intravascular access, therapy, or an arteriovenous (A-V) shunt. The cuff inflation can temporarily block blood flow, potentially causing harm to the patient.

WARNING: Pressurization of the cuff can temporarily cause loss of functionality of SpO₂ if simultaneously using device on the same limb.

WARNING: DO NOT use if device is dropped and/or is damaged. Have a qualified service representative check the unit before using again. Repairs should only be conducted by an authorized SunTech Medical service representative.

WARNING: Before performing a procedure when device is not plugged into main power, ensure there is sufficient battery charge. If battery loses charge, device must be plugged into power supply to function.

WARNING: The USB port is only a service port and cannot be used to download data or interface with the monitor. When updating the software, the monitor cannot be in use and the accessories should not be contacting the patient.

WARNING: Do not open the memory screen while readings are in progress. If the memory screen is open while pulse oximetry or temperature readings are being taken, any new readings will not be added to memory, or be recoverable in any way.

WARNING: As with all medical equipment, carefully route patient cabling to reduce the possibility of patient entanglement or strangulation.

WARNING: Do not place the monitor or accessories in any position that might cause it to fall on the patient.

WARNING: Do not start or operate the monitor unless the setup was verified to be correct.

WARNING: Do not use the monitor during magnetic resonance imaging (MRI) or in an MRI environment.

WARNING: Do not use the monitor if it appears or is suspected to be damaged.

WARNING: Explosion hazard: Do not use the monitor in the presence of flammable anesthetics or other flammable substance in combination with air, oxygen-enriched environments, or nitrous oxide.

WARNING: To ensure safety, avoid stacking multiple devices or placing anything on the device during operation.

WARNING: To protect against injury, follow the directions below:

- Avoid placing the device on surfaces with visible liquid spills.
- Do not soak or immerse the device in liquids.
- Do not attempt to sterilize the device.

- Use cleaning solutions only as instructed in this operator's manual.
- Do not attempt to clean the device while monitoring a patient.

WARNING: To protect from electric shock, always remove the sensor and completely disconnect the monitor before bathing the patient.

WARNING: If any measurement seems questionable, first check the patient's vital signs by alternate means and then check the monitor for proper functioning.

WARNING: The monitor should not be used as the sole basis for medical decisions. It must be used in conjunction with clinical signs and symptoms.

WARNING: The monitor is not an apnea monitor.

WARNING: The monitor may not be used during electrocautery.

WARNING: The monitor should not be used for arrhythmia analysis.

WARNING: Do not adjust, repair, open, disassemble, or modify the monitor or accessories. Injury to personnel or equipment damage could occur. Return the monitor for servicing if necessary.

A CAUTION indicates a potentially hazardous situation which, if not avoided, may result in minor or moderate injury to the user, patient or damage to the equipment or other property.



CAUTION: For use only by or on the direction of a licensed veterinarian. NOT for use on humans.

CAUTION: DO NOT use the monitor for any purpose other than specified in this manual without written consent and approval from SunTech Medical.

CAUTION: DO NOT use this monitor when oscillometric pulses may be altered by other devices or techniques.

CAUTION: DO NOT disassemble device. Doing so may increase the risk of electrical shock. This monitor does not contain any user serviceable parts except for the battery. Substitution of a component or accessory different from that supplied may result in measurement error. Repairs should be undertaken only by personnel trained or authorized by SunTech Medical.

CAUTION: DO NOT sterilize this device.

CAUTION: Too frequent measurements may cause injury to the patient due to blood flow interference.

CAUTION: At the end of product life, the monitor, accessories, components and other consumable goods may become contaminated from normal use. Consult local codes and ordinances for proper disposal of equipment and other consumable goods.

CAUTION: This device contains a lithium ion battery that contains materials which may be hazardous to human health. DO NOT dispose of battery in domestic waste! Instead, please dispose of in an environmentally responsible way, or return the battery to SunTech Medical. A prepaid return label can be obtained. Please see our website for more information about our environmental policy at <http://www.suntechmed.com/about-suntech/environmental-policy>.

CAUTION: Accuracy of any blood pressure measurement may be affected by the position of the subject, the patient's physical condition, and use outside of the operating instructions detailed in this manual. Interpretation of BP measurement should be made only by a veterinarian or trained medical staff. Minimize limb movement during the measurement.

CAUTION: A compressed or kinked connection hose may cause continuous cuff pressure resulting in blood flow interference and potentially harmful injury to the patient. If the cuff fails to deflate, the operator should be instructed on how to remove the cuff.

CAUTION: Performance can be affected if used or stored outside the specified temperature and humidity ranges.

CAUTION: Replace user replaceable parts that are broken, worn, missing, damaged, incomplete, or contaminated. Contact SunTech Medical for service on parts that are not user replaceable and stop using device until repaired. Failure to repair a damaged product may cause injury to the user and/or patient.

CAUTION: Do not place the monitor where the controls can be changed by the patient.

CAUTION: Electrical shock and flammability hazard: Before cleaning, always turn off the device and disconnect from any power source.

CAUTION: Do not place the monitor on electrical equipment that may affect the device, preventing it from working properly.

CAUTION: To ensure that alarm limits are appropriate for the patient being monitored, check the limits each time the monitor is used.

CAUTION: Electrical Shock Hazard: Carry out periodic tests to verify that leakage currents of patient-applied circuits and the system are within acceptable limits as specified by the applicable safety standards. The summation of leakage currents must be checked and in compliance with IEC 60601-1 and UL60601-1. The system leakage current must be checked when connecting external equipment to the system. When an event such as a component drop of approximately 1 meter or greater or a spillage of blood or other liquids occurs, retest before further use. Injury to personnel could occur.













CAUTION: Disposal of product - Comply with local laws in the disposal of the device and/or its accessories.





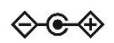























CAUTION: To minimize radio interference, other electrical equipment that emits radio frequency transmissions should not be in close proximity to the pulse oximeter.

2. Icons and Symbols

Some of the symbols listed in the table below refer to the following FDA SDO Consensus standards:

- Recognition #5-103, ISO 7000: 2014: Graphical symbols for use on equipment - Registered symbols
- Recognition #5-116, ISO 7010: 2011: Graphical symbols - Safety colours and safety signs - Registered safety signs
- Recognition #5-102, ISO 60417: 2002 DB: Graphical symbols for use on equipment
- Recognition #5-117, ISO 15223-1: 2016: Medical devices - Symbols to be used with medical device labels, labelling, and information to be supplied - Part 1: General requirements

Symbol	Description	Standard/Source
	General Warning Sign	ISO 7010-W001
	Batch Code	ISO 7000-2492
	Caution	ISO 7000-0434A
	Classification – Class II	IEC 60417-5172
	Refer to Instruction Manual	ISO 7010-M002
	Authorized representative in the European Community	SunTech Design
	USB-A or USB-B	Industry
	Direct Current	IEC 60417-5031
	Alternating Current	IEC 60417-5032
	Polarity of DC power connector	IEC 60417-5926
	Rechargeable battery	IEC 60417-5639
	Consult Instructions for Use	ISO 7000-1641
	This product meets the requirements of the applicable Directives	EU Directive
	Disposal in compliance with WEEE Directive	WEEE Directive

	Manufacturer	ISO 7000-3082
	Date of Manufacture	ISO 7000-2497
	Serial Number	ISO 7000-2498
	Cuff index line must fall within range markings	SunTech Design
	Arrow should be placed over artery	SunTech Design
	Symbol indicating limb circumference	SunTech Design
	Index line	SunTech Design
	Not made with natural rubber latex	SunTech Design
	Not made with PVC	SunTech Design
	Reference Number	ISO 7000-2493
	Type BF Applied Part	IEC 60417-5333
	Fragile, handle with care	ISO 7000-0621
	Humidity Limits	ISO 7000-2620
	Temperature Limits	ISO 7000-0632
	Keep Dry	ISO 7000-0626
	Accesses Settings screen	SunTech Design
	Small animal mode	SunTech Design
	Large animal mode	SunTech Design
	Opens the Icon Menu	SunTech Design
	Begins Interval BP Mode	SunTech Design
	Adjusts volume	SunTech Design
	View Memory	SunTech Design
	Exits or closes a screen	SunTech Design
	Goes back to previous screen	SunTech Design
	Deletes all stored memory data	SunTech Design
	Averages selected BP readings	SunTech Design
	Begins STAT Mode	SunTech Design
	Bluetooth	Bluetooth



Begins data transfer

SunTech Design

TIP:

Provides practical advice for using monitor

SunTech Design



Maximize or minimize a focus screen

SunTech Design



Standby (Powers device on/off)

IEC 60417-5009



Start/Stop a BP measurement

IEC 60417-5107B

IEC 60417-5110B



Battery Indicator

SunTech Design

IPX1

SpO₂ Sensors only: These items are protected against ingress of vertically dripping water only

IEC 60529

3. Getting to Know SunTech Vet30

3.1 Applied Parts and Patient Environment

The applied parts are type BF. The following are the applied parts of the Vet30:

- BP Cuffs
- SpO₂ Sensors
- Temperature Probes

The Vet30 has been tested with specific parts of the system used within the patient environment. The parts of the system that can be used in the patient environment are:

- Vet30 monitor
- All applied parts as defined above
- All accessories as defined in Section 10.5, excluding the AC Adapter

The patient environment is defined in the following diagram:

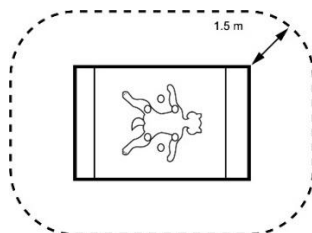

3.2 Device Placement



WARNING: As with all medical equipment, carefully route patient cabling to reduce the possibility of patient entanglement or strangulation.



CAUTION: Do not position the monitor so that it is difficult to access and remove the AC adapter from the electrical supply mains. The power supply is the means of disconnection to the supply mains.

Place the Vet30 monitor in a convenient location to ensure user's ability to monitor the screen continuously. Ensure monitor is placed away from table top edges and route the patient cables so that if pulled, the monitor will not fall.

3.3 Front Panel



Power button.
Press once to turn ON. The button is illuminated when power is on.
To turn OFF, press the button again.

Start/Stop button.
Starts BP measurement. Stops measurement at any time.

3.4 Connect Power, Hose, and Sensors



CAUTION: Read all warnings, cautions, and instructions provided prior to using the device.

1. Insert AC adapter plug into the Vet30. Plug other end of the AC adapter into a power supply to begin charging the battery. Only use AC Adapter supplied by SunTech Medical.



WARNING: The AC adapter must be unplugged and the battery must be disconnected in order to completely disconnect device from power. *See Section 10.3 for information on battery disconnection.*

2. Connect the patient hose to the back of the monitor making sure the connector “clicks” into the locking position by rotating clockwise. *For additional information on how to take a BP measurement, see Section 5.*



3. Plug AccuVet temperature probe into the back of the monitor. Be sure to fully insert the connector into the monitor to avoid erroneous temperature values. *For additional information on how to take a temperature measurement, see Section 6.*

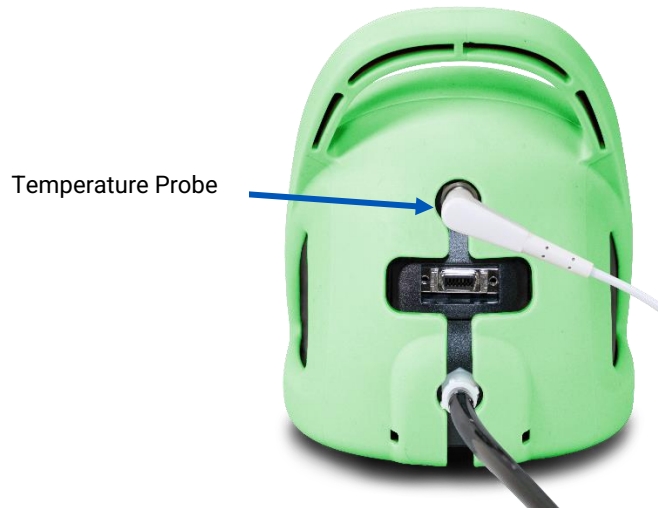

4. Connect SpO₂ Sensor

A) AccuVet SpO₂

Plug AccuVet SpO₂ Y-lingual Sensor, Reflectance Sensor, or extension cable into the back of the monitor. Lift retaining clip in place. If applicable, attach sensor to extension cable and lock plastic hinged cover to prevent accidental disconnection. *For additional information on how to take an SpO₂ measurement, see Section 7.*

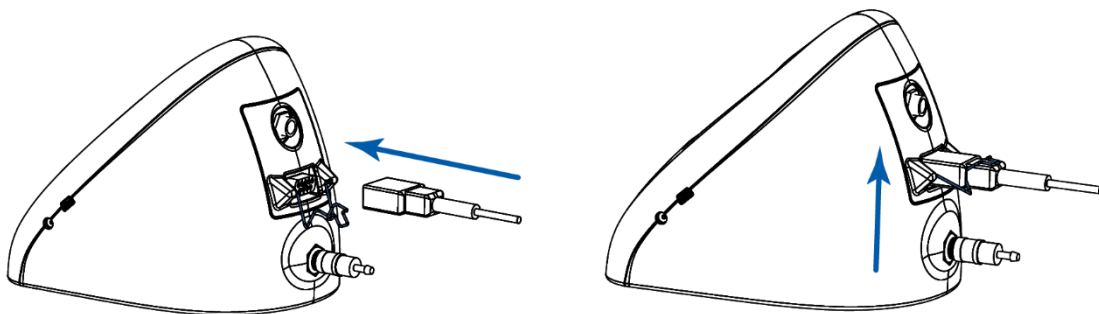



B) Masimo SpO₂

- a. Attach the LNC Patient Cable to the Vet30. Orient the connector of the cable to mate with the patient cable connector on the back of the Vet30 and insert.



- b. Attach the LNC Patient Cable connector to a LNCS reusable sensor connector. Orient sensor connector (1) to patient cable connector (2) as shown. Insert sensor connector (1) completely into patient cable connector (2). Close sensor connector cover (3) over patient cable connector until it locks in place. *For additional information on how to take an SpO₂ measurement, see Section 7.*

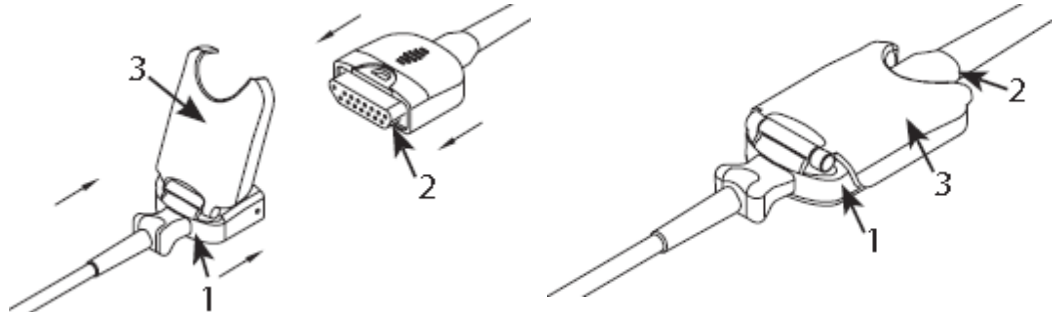

3.5 Display

Animal Selection Screen

When you turn on your SunTech Vet30, you will see the Animal Selection Screen. Even if you are not ready to measure BP on a patient, select either Large or Small animal so that you can proceed to the Main Screen. This screen can be turned off (*see Animal Selection in Section 4*). Additionally, the animal mode can be toggled using the animal selection icon on the Main screen.

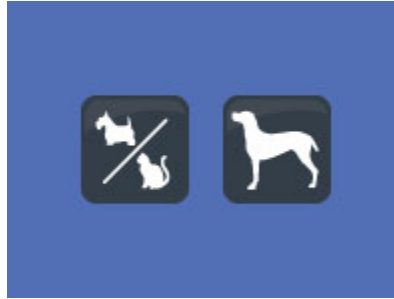

Main Screen

After you begin using your Vet30, your main screen will display your most recent patient measurements. Here is a quick overview of the key symbols and numeric values you will see. Prior to the first reading upon power on, the screen will display dashes instead of values.

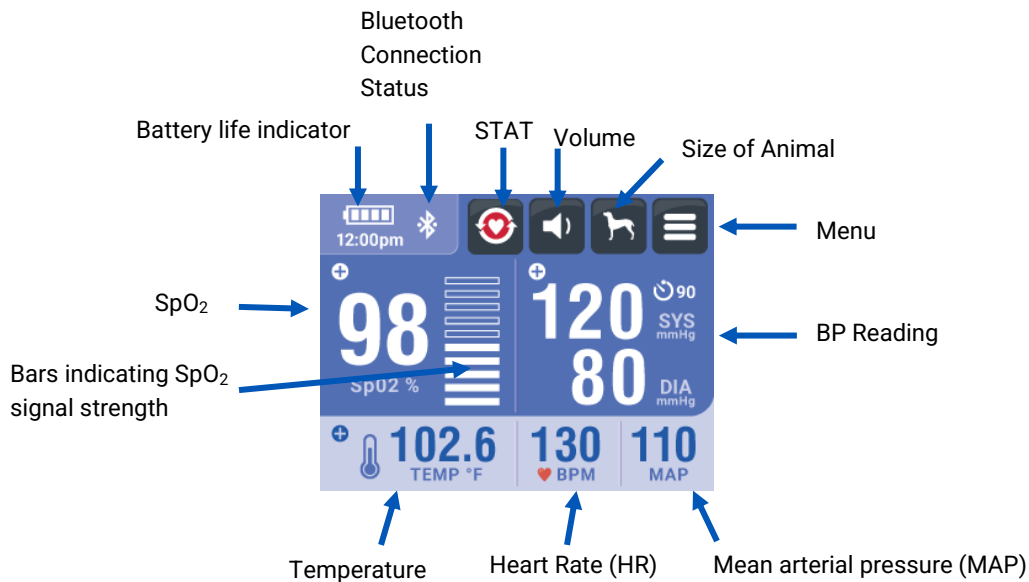

Icon Menu

After you press on the Menu button on the main screen, the Icon Menu will open. Here you can access various functions and settings of the device. The Icon Menu is not accessible during a BP measurement.

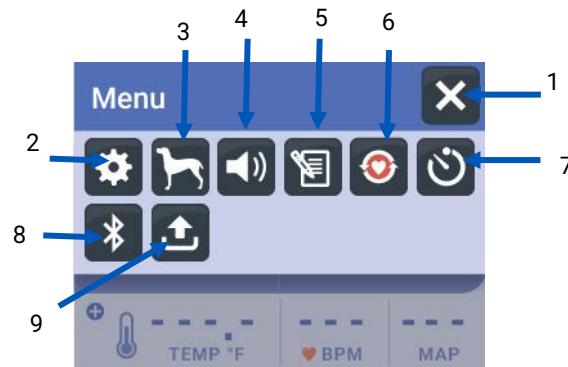

1. Exit Icon Menu
2. Settings
For more information on selecting settings, see Section 4.3
3. Animal Selection
4. Speaker Volume
5. Memory
For more information on reviewing and transferring data, see Section 8
6. STAT Mode
For more information on STAT BP Mode, see Section 5.5
7. Interval BP Mode
For more information on Interval BP Mode, see Section 5.4
8. Bluetooth Connect
For more information on Bluetooth connection, see Section 8.3
9. Data Transfer
For more information on reviewing and transferring data, see Section 8

Focus Screens

For more detailed information on temperature, BP, or SpO₂, touch the + in the top left corner of the measurement section. This expanded view provides a more detailed look at the measurement. To exit the focus screen, touch the - in the top left corner of the screen.



Temperature Focus Screen

- Larger view of the current temp reading



BP Focus Screen

- Larger view of the current BP reading



SpO₂ Focus Screen

- Larger view of the current SpO₂ % and HR reading
- Plethysmograph waveform
TIP: The waveform is not normalized.

3.6 Start/Stop Button

The color of the LED on the START/STOP button indicates the status of the Vet30.



- START/STOP button is magenta during normal operation
- START/STOP button is blue during a BP reading
- START/STOP button is white when in service mode
- START/STOP button is red during an error, when a status message is prompted or the device is unable to connect via Bluetooth

4. Selecting Your Settings

TIP: Selected settings are saved even when device is powered off.

4.1 Animal Mode

Small Animal Mode should be chosen when taking BP measurements on cats and dogs up to a #3 BP cuff size. This size typically applies to dogs or cats weighing less than 8kg (~17.5 lbs.). Large Animal Mode has been designed for animals requiring a #4 BP cuff or larger. This size typically applies to dogs weighing more than 8 kg (~17.5 lbs.). If a problem arises, try switching animal modes by touching the Animal Selection button on the main screen or in the menu.



4.2 Volume

The SunTech Vet30 monitor's default setting is Speaker Off so that patients are not disturbed by sounds. To toggle between Speaker Off, Low Volume, and High Volume, press the Speaker button. When sound is OFF, you still will hear a very quiet clicking when you touch buttons but no beeps.



4.3 Settings

To access the settings screen, select the settings button () in the menu.

Clinical Alarms.
Provides access to turning ON and setting clinical alarms.

Interval BP.
Select time between BP measurements in Interval BP Mode.



Power Management.
Select how long monitor stays on before Auto OFF shutdown. Auto OFF is disabled when powered by an AC adapter.

Animal Selection.

Time. Set the time.
Date. Set the date.



Temperature.
 Select the units for temperature.
 Language.
 Select desired language.

Clinical Alarms

The SunTech Vet30 allows clinical alarms for all values (SYS, DIA, MAP, HR, Temp, and SpO₂). Factory setting is OFF.

- To change alarm values, select the Settings screen in the Icon Menu, then choose Clinical Alarms.
- Select the parameter of interest.



- Touch On, then Set Alarm Values.
- Touch the numeric range value that you want to adjust. The alarm range cannot be adjusted by dragging the blue bar. The value on the left side represents the value for which all values below that number will trigger the alarm. The value on the right side represents the value for which all values above that number will trigger the alarm.

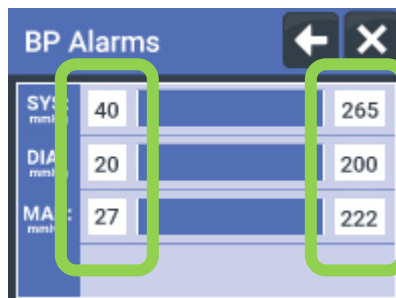

Touch the numbers on the right or left to set the alarm limits.

- Using the keypad, type in the desired value and touch the checkmark.



- To reset to default clinical alarms, touch Use Defaults. For information on the default clinical alarm values, see Section 14.
- When alarm is triggered, values that are outside of the set ranges will turn red on the Main Screen. If speaker is ON, a beep will occur. *For more information on alarms, see Section 10.*

Power Management

The Vet30 includes an Auto OFF feature which turns the monitor off after a selected period. The Auto OFF timer is disabled when powered by an AC Adapter and during Interval Measurement Mode. To edit the Auto OFF timer, select the Settings screen in the Icon Menu, then choose Power Management. Factory setting is 10 minutes. Auto-off Timer may be set to 5, 10, and 20 minutes or Always ON.

TIP: Battery charge may be rapidly depleted if set to always ON.

Note: Only use the power cord provided (Part Number: 19-0020-00).

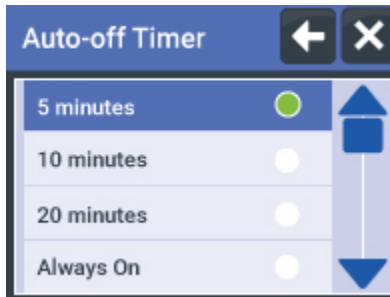

Interval BP

To set the time between BP measurements during Interval Mode, select the interval time desired. To access the Interval BP options, select the Settings screen in the Icon Menu, then choose Interval BP.

- Intervals include 1, 2, 3, 4, 5, 10, 15, 30, 60, and 90 minutes
- After setting the interval time, there will be a choice to either begin Interval BP Mode immediately or to exit without starting Interval BP Mode. To begin Interval BP Mode at a previously set interval, click the Interval BP icon in the Icon Menu. *For more information on Interval BP Mode, see Section 5.*

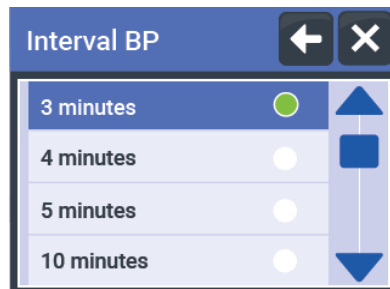

Animal Selection

The animal selection start up screen can be turned OFF. This is useful for clinics catering to a specific species such as an all cat clinic. To change the animal selection screen options, select the Settings screen in the Icon Menu, then choose Animal Selection.

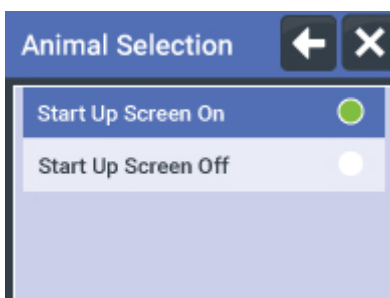

Temperature

Select between Fahrenheit or Celsius for temperature units. To access the temperature options, select the Settings screen in the Icon Menu, then choose Temperature.



Time

To set the internal clock, select the Settings screen in the Icon Menu, then choose Time.

- Two time formats are available: AM/PM and 24 Hour.
- Select the desired time format and touch Continue.

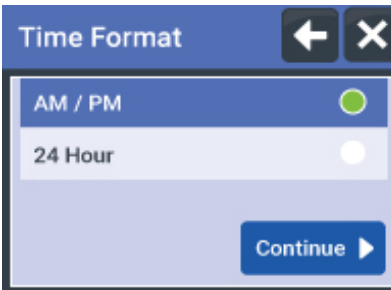

- Use the + and – buttons to select the hour and minute. In AM/PM format, touch the AM or PM button to toggle between them.



- To exit without changing the time, touch Cancel. To save the time, select Set.

Date

To set the date, select the Settings screen in the Icon Menu, then choose Date.

- Two date formats are available: MM.DD.YY and DD.MM.YY
- Select between the two date formats and touch Continue.



- Use the + and – buttons to set the day, month, and year and touch Set to save the date.

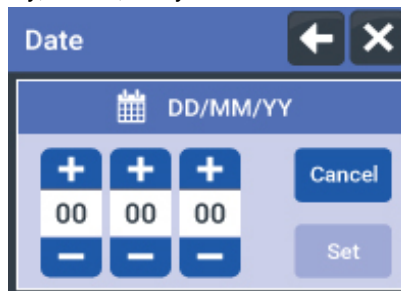

- Touch Cancel to return to the Date Format screen without changing the date. Press X to exit to the main screen.

Language

Multiple languages are available including English, French, Italian, German, Spanish and Portuguese. To access the languages, select the Settings screen in the Icon Menu, then choose Language.

- Touch the desired language to select it. Press X to save and exit.



5. Blood Pressure Measurement

5.1 Cuff Sizing

The SunTech Vet30 comes with a variety of different BP cuff sizes. Each cuff contains important markings that help with selecting the right cuff size. These are SunTech designed symbols.

ARTERY



Make sure this part of cuff is placed over the patient's artery.



When the cuff is wrapped around the patient's limb, its Index Marker should fall within this line.



When you wrap the cuff around the patient's limb, the Index Marker should fall within the Range Marker on the inside of the cuff.



Indicates limb circumference range of the cuff.



Not made with natural rubber latex.



Not made with PVC.

TIP: When more than one cuff size fits the limb, always choose the larger size for more accurate measurements. When a cuff is too small, it can cause BP values to be overestimated.

An alternative sizing method is to measure the circumference of the limb and choose a cuff whose width is 40% of the circumference for dogs and 30% for cats.

5.2 Where to Apply the Cuff



WARNING: The cuff should not be applied over a wound as this can cause further injury.

SunTech recommends that the cuff be placed on a front limb while the patient is lying on the right or left side. This helps ensure that the cuff is at heart level, which is best for measurement accuracy. Also, the patient is less likely to retract the front limb when the cuff gently squeezes it during the measurement. The cuff should be placed so that its artery marker aligns with the limb artery.

Alternate Patient Positioning: If the patient seems more comfortable seated, position the cuff as described above and hold up the limb during the BP measurement. This will help keep the cuff at heart level and relax the patient's muscles. If the patient appears agitated enough to bite or scratch, or is standing, the base of the tail is an acceptable alternate location.

5.3 Taking a BP Measurement

1. Position patient so that they are lying down, seated, or held. Place the cuff on the limb making sure not to place it over a joint. Connect cuff hose to monitor hose.

TIP: The success of the BP measurement is dependent on choosing the correct cuff and attaching it to the patient correctly. The cuff is the sensor so make sure to snugly fit the cuff as this provides better signals to the monitor.

2. Press the Power Button to turn on the Vet30. Select Large or Small animal size.

TIP: To change animal size after initial selection, touch the Animal Selection icon on Main Screen to toggle between Large and Small. *For more information on selecting animal size, see Section 4.*

3. Allow patient to acclimate for approximately 5 minutes in a quiet area. Press START/STOP button to start blood pressure measurement. START/STOP button turns blue during measurement. Reading is complete when START/STOP button returns to magenta. Main Screen will show systolic (SYS) and diastolic (DIA) values, plus mean arterial pressure (MAP) and heart rate (HR) in beats per minute.

TIP: During a BP reading, the Icon Menu is not available. To access the Icon Menu, either wait until the BP reading is complete or stop the reading by pressing the START/STOP button.

TIP: When a BP reading is in progress, pressing the START/STOP button will immediately stop the measurement and deflate the cuff.

TIP: For information on averaging BP measurements, see Section 8.2.

5.4 Interval BP Mode

In Interval BP Mode, the SunTech Vet30 automatically takes a BP reading at set time intervals. The time interval can be changed through the Interval BP settings (*see Section 4.3*).

- To start taking BP measurements in Interval Measurement Mode, enter the Icon Menu, then touch the Interval BP

icon: 

- The Icon Menu will close and the first BP measurement will automatically begin. Once the BP reading has finished, the device will wait the set amount of time before automatically taking another BP reading.
- When the SunTech Vet30 is in Interval Measurement Mode, a clock icon will appear on the screen, indicating the set time interval.
- An additional BP reading can be taken by manually pressing the START/STOP button in between Interval BP readings.
- During a BP reading, the Icon Menu is not available. If an Interval BP reading is scheduled to start and the Icon Menu or a Settings screen is open, the scheduled BP reading will not begin until the display is returned to the Main Screen or a focus screen.
- To exit Interval BP Mode, touch the Interval BP icon in the Icon Menu or press the START/STOP button during a BP measurement.

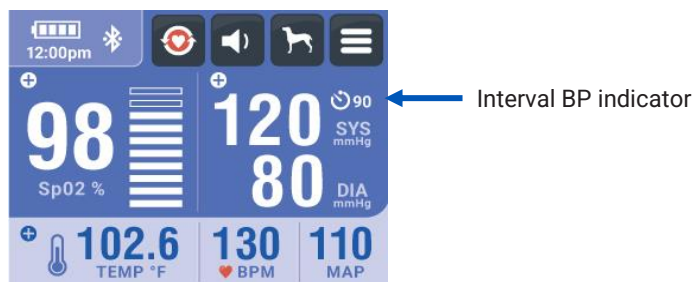

TIP: For information on setting the amount of time between interval measurements, see Section 4.3.

5.5 STAT Mode



WARNING: Check the limb frequently to ensure that operation of the monitor does not result in prolonged impairment of the circulation of the patient.

During STAT Mode, the SunTech Vet30 will automatically take continuous BP measurements for 10 minutes.

- To enter STAT Mode, select the STAT icon at the top of the Main Screen.
- Alternatively, enter the Icon Menu, then touch the STAT icon.
- When the device is in STAT Mode, the STAT icon is displayed on the main screen.
- During a BP reading, the Icon Menu is not available.
- To exit STAT Mode, touch the STAT icon again or press the START/STOP button while a BP measurement is in progress. STAT Mode will automatically stop after 10 minutes.

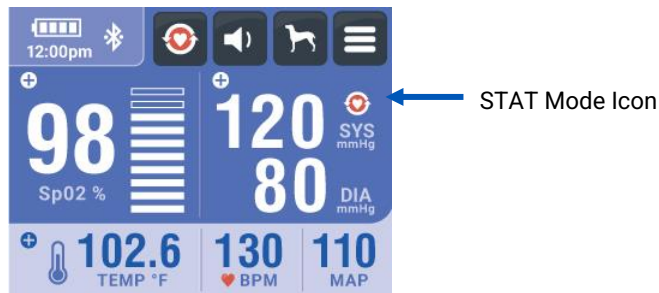

5.6 Interrupting/Stopping a Measurement

To abort a measurement while in progress, touch the START/STOP button. When a BP reading is in progress, pressing the START/STOP button will immediately stop the measurement and deflate the cuff. An abort message will appear on the screen and a short beep will sound if volume is on. The START/STOP button returns to magenta and monitor gets ready to start a new reading.

5.7 Heart Rate Measurement

Heart rate can be measured either through the SpO₂ sensor or through a BP measurement. When the SpO₂ sensor is plugged in, the heart rate derived from that measurement will take precedence over the heart rate derived from the BP measurement.

6. Temperature Measurement

6.1 Where to Apply the Temperature Probe

Clean the probe before use. *See Section 11 for cleaning instructions.* The AccuVet temperature probe may be placed either in the esophagus or the rectum while the patient is lying down. Placement is not interchangeable so proper probe labeling is encouraged to avoid cross-contamination.

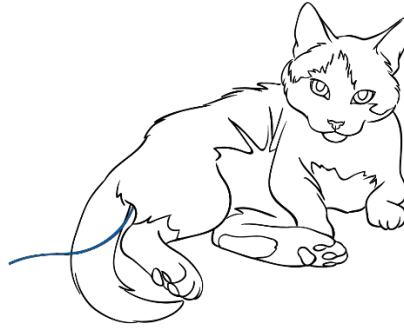
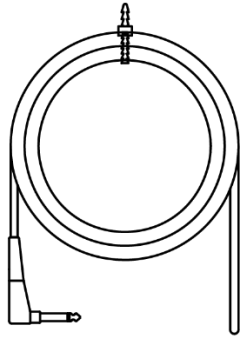

CAUTION: Label usage of temperature probe to avoid cross-contamination.

Disposable, non-rigid thermometer probe covers can be used as needed. Users should ensure probe covers are used in accordance with manufacturers' instructions.

6.2 Taking a Temperature Measurement

TIP: Clean the probe before and after each use making sure to remove all bioburden.

1. Place temp probe on patient and connect to Vet30. Position patient so that they are lying down. Apply disposable, non-rigid probe cover if using. Place the probe either in the esophagus or rectum.

TIP: Placement is not interchangeable so proper probe labeling is encouraged to avoid cross-contamination.

2. Power up and select animal mode. Once the temperature probe senses a reading from a patient, the values will display on the screen. Verify that the probe is properly positioned and correctly detecting the temperature by watching several seconds of data. While the device is searching for a temperature measurement, dashes will appear on the screen.

TIP: See Section 4 to learn how to change the temperature units displayed.

7. SpO₂ Measurement

The Vet30 is to be operated by, or under the supervision of, qualified personnel only. The manual, accessories, directions for use, all precautionary information, and specifications should be read before use. *See Section 10.2 for cleaning instructions.*



WARNING: Only use the AccuVet SpO₂ accessories with the model M30A. Only use the Masimo SpO₂ accessories with the model M30B.

WARNING: Inaccurate SpO₂ readings may be caused by:

- Improper sensor application and placement
- Elevated levels of COHb or MetHb: High levels of COHb or MetHb may occur with a seemingly normal SpO₂. When elevated levels of COHb or MetHb are suspected, laboratory analysis (CO-Oximetry) of a blood sample should be performed.
- Elevated levels of bilirubin
- Elevated levels of dyshemoglobin
- Vasospastic disease, such as Raynaud's, and peripheral vascular disease
- Hemoglobinopathies and synthesis disorders such as thalassemias, Hb s, Hb c, sickle cell, etc.

- Hypocapnic or hypercapnic conditions
- Severe anemia
- Very low arterial perfusion
- Extreme motion artifact
- Abnormal venous pulsation or venous constriction
- Severe vasoconstriction or hypothermia
- Arterial catheters and intra-aortic balloon
- Intravascular dyes, such as indocyanine green or methylene blue
- Externally applied coloring and texture, such as nail polish, acrylic nails, glitter, etc.
- Birthmark(s), tattoos, skin discolorations, moisture on skin, deformed or abnormal fingers. etc.
- Skin color disorders

WARNING: Interfering Substances: Dyes or any substance containing dyes that change usual blood pigmentation may cause erroneous readings.

WARNING: Masimo SpO₂ is empirically calibrated in healthy adult volunteers with normal levels of carboxyhemoglobin (COHb) and methemoglobin (MetHb).

WARNING: Measuring SpO₂ in the presence of bright light may result in inaccurate measurements. In such cases, cover the sensor site with an opaque material.

WARNING: Do not apply tape to secure the sensor in place or to tape it shut. Venous pulsations may lead to inaccurate saturation measurements.

WARNING: Pressurization of the cuff can temporarily cause loss of functionality of SpO₂ if simultaneously using device on the same limb.

WARNING: Excessive pressure by a pulse oximeter probe for prolonged periods can induce pressure injury.



CAUTION: When patients are undergoing photodynamic therapy, they may be sensitive to light sources. Pulse oximetry may be used only under careful clinical supervision for short time periods to minimize interference with photodynamic therapy.

CAUTION: If SpO₂ values indicate hypoxemia, a laboratory blood sample should be taken to confirm the patient's condition.

CAUTION: Variation in measurements may be profound and may be affected by sampling technique as well as the patient's physiological conditions. Any results exhibiting inconsistency with the patient's clinical status should be repeated and/or supplemented with additional test data. Blood samples should be analyzed by laboratory instruments prior to clinical decision making to completely understand the patient's condition.

CAUTION: Do not submerge the pulse oximeter in any cleaning solution or attempt to sterilize by autoclave, irradiation, steam, gas, ethylene oxide or any other method. This will seriously damage the pulse oximeter.

7.1 Masimo Pulse Oximetry

Masimo Patents: www.masimo.com/patents.htm

Possession or purchase of this device does not convey any express or implied license to use the device with unauthorized sensors or cables which would, alone or in combination with this device, fall within the scope of one or more of the patents relating to this device.

NOTE: A functional tester cannot be used to assess the accuracy of the pulse oximetry function of the Vet30.

NOTE: High-intensity extreme lights (such as pulsating strobe lights) directed on the sensor, may not allow the Vet30 to obtain vital sign readings.

NOTE: Do not loop the patient cabling into a tight coil or wrap around the device, as this can damage the patient cabling.

NOTE: Additional information specific to the Masimo sensors compatible with the Vet30, including information about parameter/measurement performance during motion and low perfusion, may be found in the sensor's directions for use (DFU).

NOTE: Cables and sensors are provided with X-Cal™ technology to minimize the risk of inaccurate readings and unanticipated loss of patient monitoring. Refer to the Cable or Sensor DFU for the specified duration of the patient monitoring time.

Where to Apply the Masimo LNCS YI AH Multisite Reusable Sensor



CAUTION: Exercise extreme caution with poorly perfused patients; skin erosion and/or pressure necrosis can be caused when the sensor is not frequently moved. Assess site as frequently as every hour with poorly perfused patients and move the sensor if there are signs of tissue ischemia.

To attach the AH clip to the YI AH Sensor:

1. Grasp the pad of one of the sensor pads on the sensor, slide the end of the sensor head into the clip with the black side facing out.
2. Once the head of the sensor pad is engaged in the clip, push the pad down into the round end of the clip.
3. Repeat with the other sensor pad on the opposite window.

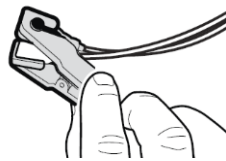

Application site should be cleaned of debris and dry prior to sensor placement. Dark pigmentation, thick fur, ambient light, low or poor perfusion, and movement of the sensor at the site may impact the accuracy of pulse oximetry. Possible application sites include tongue, lip, ear, prepuce or vulva, toe, paw, or nostril. *For instructions on connecting the Masimo sensor and patient cable, see Section 3.*

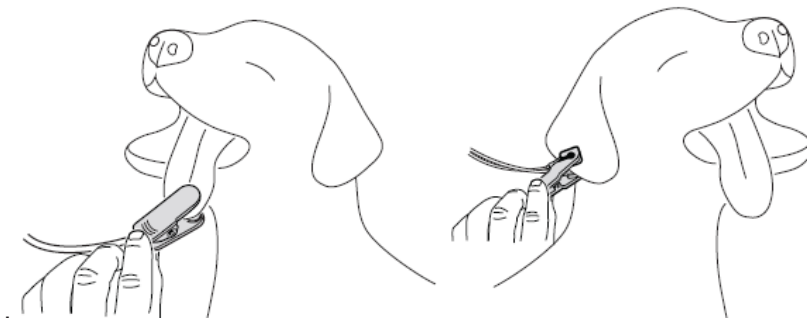

To disconnect the sensor:

1. Lift the protective cover to gain access to the sensor connector.
2. Pull firmly on the sensor connector to remove the patient cable. To avoid damage, pull on the sensor connector, not the cable.

To disconnect the sensor from the clip:

1. Gently lift each sensor pad up and out of the clip.

Where to Apply the Masimo LNCS TF-I AH Reusable Transflectance Sensor



CAUTION: Exercise extreme caution with poorly perfused patients; skin erosion and/or pressure necrosis can be caused when the sensor is not frequently moved. Assess site as frequently as every hour with poorly perfused patients and move the sensor if there are signs of tissue ischemia.

Application site should be cleaned of debris and dry prior to sensor placement. Dark pigmentation, thick fur, ambient light, low or poor perfusion, and movement of the sensor at the site may impact the accuracy of pulse oximetry. Recommended application site is ventral tail-base.

1. Apply the sensor to the patient at the selected monitoring site as shown below and gently press on the sensor so that the adhesive tab forms a good contact with patient's skin.

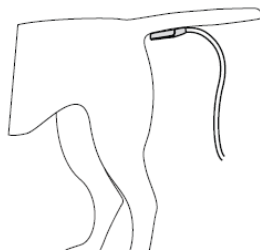

2. Connect the sensor connector and the patient cable connector, securing with the protective cover. *For complete instructions on connecting the Masimo sensor and patient cable to the Vet30, see Section 3.*

To disconnect the sensor:

1. Lift the protective cover to gain access to the sensor connector.
2. Pull firmly on the sensor connector to remove the patient cable. To avoid damage, pull on the sensor connector, not the cable.

Taking a Masimo SpO₂ Measurement

1. Place SpO₂ sensor on patient and connect to Vet30 as described above.
2. Power up and select animal mode. Once the SpO₂ sensor is connected and sensing a reading, the monitor will begin to beep at the pulse rate. The bars in the bar graph will indicate the signal strength and pulse rate. When more bars are filled in, the signal strength is stronger. The monitor will not beep if speaker is OFF. Verify that the sensor is properly positioned and correctly detecting the SpO₂ % by watching several seconds of data. When the monitor is searching for a signal, the dashes in the SpO₂ section of the screen will flash. If the monitor is having trouble obtaining SpO₂ %, re-position the sensor to another location. The measurement site must be changed every 4 hours to guarantee the integrity of the patient's skin.

If the SpO₂ sensor falls off or is removed from the patient, the pulse rate beep will stop and dashes will appear on the screen in place of the SpO₂ reading. If volume is on, an audible tone will sound.

TIP: For systems that include SpO₂ and it is currently being monitored, the SpO₂ heart rate takes precedence over the BP heart rate.

Troubleshooting an SpO₂ Measurement

Potential causes of difficulty in obtaining a reading can include:

- Improper sensor type or application
- Low perfusion
- Excessive motion artifact
- Excessive ambient or strobing light
- Low battery/not plugged into AC power supply

When troubleshooting a difficulty in obtaining a reading, ensure the following steps are taken:

- Allow time for reading to stabilize

- Verify sensor type and check connection to Vet30
- Check if blood flow to the sensor site is restricted
- Check the placement of the sensor and re-apply sensor if needed
- Replace sensor if defective
- Shield the sensor from excessive or strobing light
- Minimize motion at the monitoring site
- Connect the AC power supply

Refer to the Directions for Use included with the Masimo sensor for additional application information.

7.2 AccuVet Pulse Oximetry

NOTE: A functional tester cannot be used to assess the accuracy of the pulse oximetry function of the Vet30.

Where to Apply the AccuVet Y-lingual SpO₂ Sensor

1. Clean the sensor before use.
2. Select the sensor clip that is appropriate for the patient.
3. Open clip with thumb and a finger. For each side of the clip, push the sensor alignment buttons into the clip slots until they are fully engaged. Verify that the sensor pads are properly aligned with each other.
4. Apply the sensor to the patient at the tongue or alternatively at the lip, ear, skin between toes, prepuce or vulva while the patient is lying down.

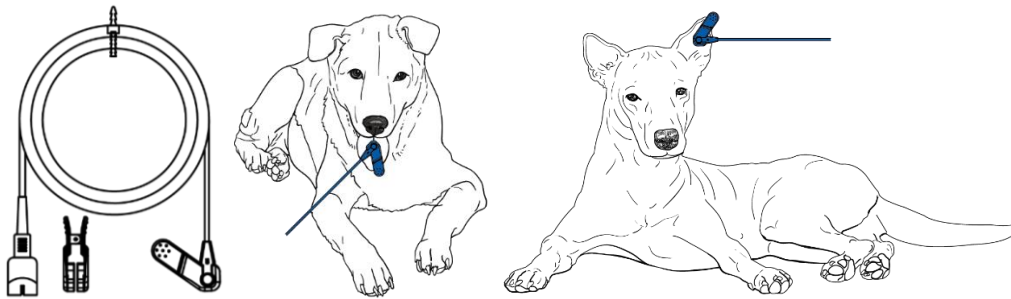

Where to Apply the AccuVet Reflectance SpO₂ Sensor

1. Clean the sensor before use.
2. Apply disposable, non-rigid covers as needed. Users should ensure sensor covers are used in accordance with manufacturers' instructions.
3. Place sensor in the rectum.

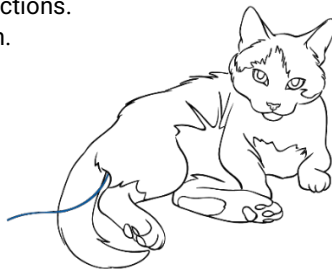

CAUTION: The reflectance sensor is not designed for long-term monitoring. It must be moved every 4 hours (or more often, if indicated by circulatory status and/or skin integrity) and reapplied to a different site.

TIP: If the sensor does not measure the pulse of the patient reliably, it may be incorrectly positioned or skin may be pigmented. If any of these situations occurs, reposition the sensor.

Taking an AccuVet SpO₂ Measurement

TIP: Clean the sensor before use and after each use.

1. Place SpO₂ sensor on patient and connect to Vet30. *For information on connecting the SpO₂ sensor, see Section 3.* Position patient so that they are lying down. Apply the sensor to the patient at the tongue or alternatively at the lip, ear, skin between toes, prepuce or vulva. If using rectal reflectance SpO₂ sensor, place in patient's rectum, using disposable, non-rigid covers as needed.

2. Power up and select animal mode. Once the SpO₂ sensor is connected and sensing a reading, the monitor will begin to beep at the pulse rate. The bars in the bar graph will indicate the signal strength and pulse rate. When more bars are filled in, the signal strength is stronger. The monitor will not beep if speaker is OFF. Verify that the sensor is properly positioned and correctly detecting the SpO₂ % by watching several seconds of data. When the monitor is searching for a signal, the dashes in the SpO₂ section of the screen will flash. If the monitor is having trouble obtaining SpO₂ %, re-position the sensor to another location. The measurement site must be changed every 4 hours to guarantee the integrity of the patient's skin.

If the SpO₂ sensor falls off or is removed from the patient, the pulse rate beep will stop and dashes will appear on the screen in place of the SpO₂ reading. If volume is on, an audible tone will sound.

TIP: For systems that include SpO₂, the displayed heart rate is derived from the SpO₂ sensor, rather than the NIBP cuff when SpO₂ is being monitored.

Troubleshooting an SpO₂ Measurement

If a sensor is connected to the Vet30 and to the patient, but not displaying a reading, observe the display for one minute to determine if the monitor is searching for a reading. When the monitor is searching for a signal, the dashes in the SpO₂ section of the screen will flash. Dashes indicate that the signal may be inadequate. If the monitor is having trouble obtaining SpO₂ %, re-position the sensor to another location. If the monitor does not appear to be searching for a reading, check the connection to the patient and to the Vet30. If no issues are found, disconnect and then re-connect the sensor. If issues continue, the sensor may need to be replaced. Contact your sales representative to purchase a replacement sensor.

7.3 Heart Rate Measurement

Heart rate can be measured either through the SpO₂ sensor or through a BP measurement. When the SpO₂ sensor is plugged in, the heart rate derived from that measurement will automatically take precedence over the heart rate derived from the BP measurement.

8. Reviewing and Transferring Data

8.1 Viewing Stored Measurements

To take additional BP readings, press START/STOP again. SpO₂ and temp readings are continuous while a patient is connected and a data point is saved to memory every 60 seconds.

Deletes all memory ↓ ↓ Averages values for selected data

Memory	🗑️	AVG	✕
🕒 / 📅	Sys	Dia	MAP HR
10:00 AM	122	80	104 120
9:45 AM	118	79	102 124
9:30 AM	🚨 Air leak in hose		
2:45 PM	119	80	103 130
1:45 PM	120	77	100 110

Memory	🗑️	✕
🕒 / 📅	SpO2	HR Temp
10:00 AM	95	100 105.3
9:59 AM	96	102 102.5
9:58 AM	94	102 102.5
9:57 AM	94	105 106.4
9:56 AM	93	107 104.2

To view previous readings, touch Menu, then touch the Memory icon. Select the parameters to view. The time and date will alternate. Up to 960 measurements can be stored in memory.

8.2 Averaging Measurements

The BP data can be averaged in the memory screen. To average measurements, touch the rows with the measurements you wish to average. Selected rows will turn green. To unselect a measurement, touch its row a second time. Limit the number of measurement rows averaged to under one hundred (100) to avoid incorrect results due to too many measurements.

Average of selected readings shows on top row with "AVG" as the identifier.

🕒 / 📅	Sys	Dia	MAP	HR
AVG	120	80	103	125
31.12.16	122	80	104	120
31.12.16	118	79	102	124
31.12.16	⚠️ Air leak in hose			
31.12.16	119	80	103	130

8.3 Bluetooth Connection

The SunTech Vet30 can pair with a PC within a 30-foot radius to transfer data via Bluetooth. To pair with a PC, the Vet Data Capture PC application must first be installed on the PC. The application is available for download from the SunTech website at <https://www.suntechmed.com/vet30-data-capture>. The PC application is supported on Windows 10, Windows 8.1, and Windows 7.

Installation and Setup

1. Download the Vet Data Capture application from the SunTech website. Double click on the zip file to extract the folder. The folder can be dragged onto the desktop for easy access to the application.
2. Insert the USB Bluetooth Transmitter into an open USB port on the PC. The computer will automatically install the Bluetooth USB.

Pairing with the Vet30

1. To turn on Bluetooth on the Vet30, touch the Bluetooth icon (📶) in the Icon Menu. The monitor will automatically attempt to pair with the other device. While the device is connecting via Bluetooth, the Start/Stop button will flash blue light. Continue to step 2 while the device is flashing blue light.
2. Open the Vet Data Capture application by double clicking on the file with the purple paw icon:

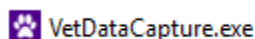

3. When the Vet Data Capture application opens, select a Vet30 for pairing. Identify the Vet30 using the last four digits of the serial number, found on the bottom of the device. *Continue to Section 6.4 for Data Transfer instructions.*

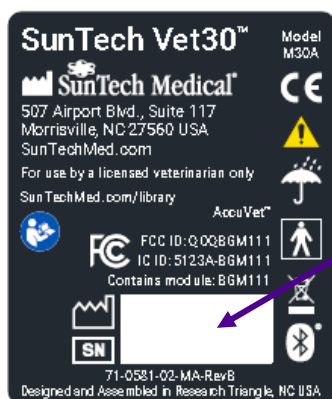

The last 4 digits of the serial number should match.

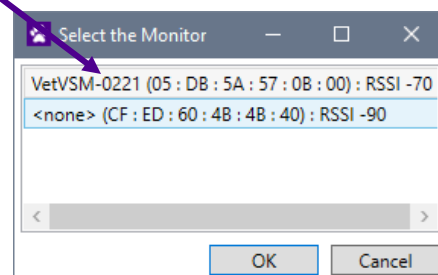

TIP: If the device is unable to connect within 90 seconds, a message will be displayed. Touch Try Again to re-attempt to connect.

TIP: During Bluetooth pairing and data transfer, ensure that the Auto Off timer is OFF to avoid the Vet30 turning off during pairing or data transfer. *For instructions on changing the Auto Off timer, see section 4.3*

To turn off Bluetooth, touch the Bluetooth icon in the Icon Menu. When Bluetooth is off, the icon will be greyed out in the Icon Menu.

8.4 Data Transfer

Once a Bluetooth connection is established with a PC, data can be transferred to the Vet Data Capture PC application.



1. To begin a data transfer, touch the Data Transfer icon () in the Icon Menu of the Vet30. A status message will pop up during the transfer on the Vet30 and will appear at the bottom of the Vet Data Capture application.
2. When data transfer is complete, the data will appear in the Vet Data Capture application. A “Transfer Complete” status message will appear on the Vet30. Select OK to clear the status message.

TIP: The Vet Data Capture PC application does not retain data when closed. *To ensure data is saved, follow instructions in section 8.5.*

8.5 Reviewing Data and Creating Reports

The SunTech PC application allows the user to create reports of patient data. Via the Bluetooth connection, all data is downloaded from the Vet30 and displayed on the software main screen in tabular format with the latest data at the top of the screen. Within the PC application, a patient name, patient ID, species, and age can be added.

Saving Patient Information

1. Select the data points for a patient by holding Ctrl and clicking on each one. For large amounts of consecutive data points, hold Shift and click the first and last data points to be included.
2. Use the text bars at the top of the screen to enter Patient Name, Patient ID, Species, and Age.

Patient Name	Patient ID	Species	Age	Apply
--------------	------------	---------	-----	-------

3. Click the Apply button to save the Patient Name, Patient ID, Species, and Age to the selected data points.
4. To correct an error, entries can be overwritten. Select the data point with incorrect information and enter the correct information into the text bars. Selecting Apply will save the new information to the data point.

Selected portions of data can be organized into a report format that includes patient information, table of most recent vital sign data, trend graphs and notes. This report can be printed or exported as a PDF file. The tabulated raw data can also be exported as a CSV file. The Vet Data Capture PC application does not retain data when closed. To ensure data is saved, follow instructions below to export the data to a PDF or CSV file.

Configuring Settings

To change the date format, time format, or temperature units within the Vet Data Capture application, open the “Configure” menu from the top of the screen.

- “Date Format” provides the option to switch between M/d/yyyy and d.M.yyyy date formats

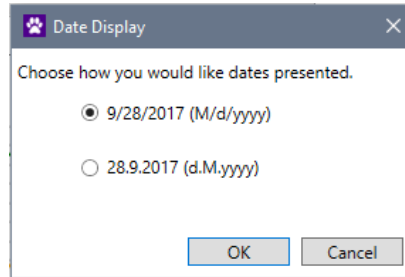

- “Time Format” provides the option to switch between time formats.

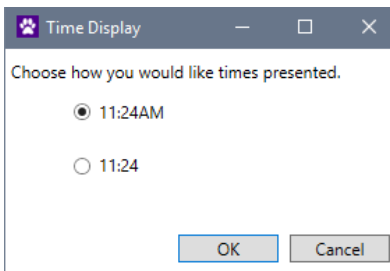

- “Temperature Units” provides the option to switch between Celsius and Fahrenheit

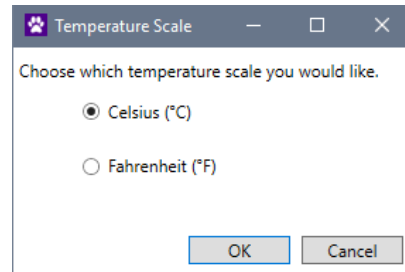

Creating a Report

1. Once data transfer is complete, select the data points to be included in the report by holding Ctrl and clicking on each one. For large amounts of consecutive data points, hold Shift and click the first and last data points to be included.

Patient Name _____

Date	Time	SYS	DIA	MAP	HR	SpO2%	Temp	Error
8/24/2001	12:47AM	111	74	86	108	0	-	
8/23/2001	1:54AM	112	69	80	90	0	-	
8/23/2001	1:34AM	138	80	95	103	0	-	
8/23/2001	1:12AM	88	36	48	82	0	-	
8/23/2001	12:49AM	118	91	99	91	0	-	
8/22/2001	6:40AM	74	62	65	172	0	-	
8/22/2001	4:45AM	114	87	95	76	0	-	
8/22/2001	3:17AM	153	130	136	119	0	-	

TIP: Only 24 hours of data can be graphed at one time. If graph contains a message saying “Maximum Limit Exceeded,” review data selected to ensure that a 24-hour period is not exceeded.

2. Click “Report”
 - a. Use the checkboxes on the left-hand side of the screen to choose if charts or a data table are included in the report.
 - b. Select “Print” to print report. Select “PDF” to save report as a .pdf file to the computer.

Once data is selected, the following actions are also available:

- To print report, click “Data” and choose “Print Report”
- To save report as a PDF file, click “Data” and choose “Create PDF”
- To save report as a CSV file, click “Data” and choose “Create CSV”

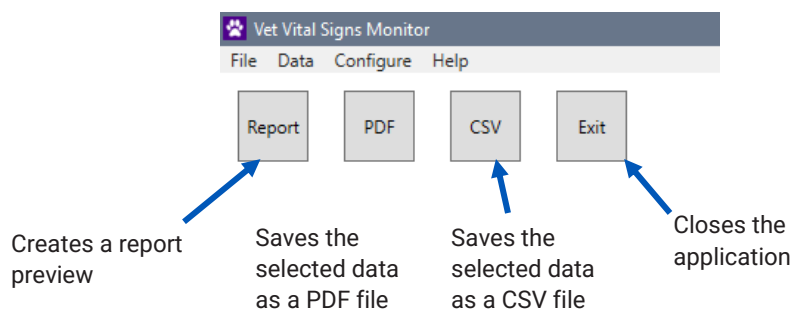

9. Alarms

9.1 Technical Alarms

A technical alarm occurs in the following situations:

- Loss of connection to a sensor
- An error during a BP measurement

During an alarm, an audible tone will sound and the parameter that is malfunctioning will display dashes. Vital sign values that are outside published values will not be displayed.

When there is an error in BP measurement, values for SYS and DIA are replaced with dashes, the START/STOP button turns red, and a long audible beep sounds if volume is on. A status message will be displayed to assist with troubleshooting the problem. *For a list of status messages, see Section 10.*

9.2 Clinical Alarms

Clinical alarms occur when a measured value meets or exceeds the high or low limit set for that parameter. The default mode for clinical alarms is OFF. *See Section 4.3 for instructions on turning on clinical alarms and setting clinical alarm values.* When a BP clinical alarm occurs, the measurement value will display in red and a long beep will sound. When a temperature, SpO₂, or heart rate clinical alarm occurs, the measurement value will display in red and flash on the screen and a tone will sound every 10 seconds while values are out of range. If it is appropriate for the patient, the alarms can be turned off. Alarms can be silenced by toggling the volume button to OFF. Always ensure that appropriate resuscitation equipment and personnel are available during the procedure. Always select alarm ranges that are appropriate for the patient and procedure. All alarms indicate a potential increased risk of injury if the test is continued.

To test the clinical alarms, turn the volume of the monitor on and set the alarm at a value likely to be exceeded with the next reading. Perform the reading. When the value exceeds the limit set, the alarm should display and a beep should sound.

10. Taking Care of the SunTech Vet30

10.1 Battery



WARNING: The internal user-replaceable battery must be plugged into a power source to maintain the battery to a full charge state. Check the battery charge status periodically, especially before a procedure where the monitor is not connected to a power source.

The Vet30 has an internal user-replaceable battery that is charging whenever the monitor is plugged into a power source. The last segment of the battery indicator will turn red when battery charge is low. During continuous monitoring of SpO₂ and temperature, with Interval BP set for every 5 minutes, a fully charged battery should last at least 4 hours before requiring recharging. If only taking manual BP measurements, a fully charged battery should last for at least 150 BP measurements before requiring recharging. Fully charging the battery should take under 6 hours. The battery should be fully recharged every 2 months when monitor is in storage.

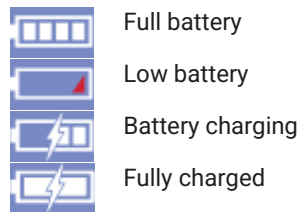

Full battery

Low battery

Battery charging

Fully charged

10.2 Cleaning

Cleaning the Vet30



WARNING: DO NOT immerse the monitor in any fluid or attempt to clean the unit with liquid detergents or solvents. This may cause an electrical hazard. Do not use the monitor if accidental wetting occurs.

As needed, clean the display using a soft, lint-free cloth sprayed with an alcohol-free glass cleaner. Dampen a soft cloth with mild medical grade disinfectant and wipe the monitor to remove surface dust and dirt.

Cleaning the Protective Armour

Wash in warm, soapy water.

Due to the manufacturing process, minor molding blemishes may be present on the protective armour. These blemishes will not impact the functionality of the armour or the monitor and are not considered defects of the product.

Cleaning the Masimo SpO₂ Accessories



WARNING: Do not immerse the connector end of the sensor cable as this may damage the sensor.

NOTE: Cleaning instructions for the LNC Patient Cable, YI AH Sensor, and TFI AH Sensor may be found in the directions for use (DFU) of those items.

Cleaning the AccuVet Temperature Probe

Clean the probe before and after each use making sure to remove all bioburden. Brief immersion of the probe in cleaning solution is acceptable except for the probe connector which must not be immersed. Disinfection of the probe and its connecting cable can be done with a soft cloth saturated with 70% isopropyl alcohol or 10% (1:10)

solution of chlorine bleach and tap water. Afterwards, wipe the probe with a soft cloth dampened with clean water. Allow the probe and cable to dry thoroughly before use.

Cleaning the AccuVet SpO₂ Y Sensor



WARNING: DO NOT immerse the SpO₂ probe in any fluid, or attempt to clean the unit with any liquid detergents or solvents. Do not sterilize. This may cause an electrical hazard.

Clean the sensor and clip before and after each use. Clean the clip, sensor, and connecting cable with warm soapy water or 70% isopropyl alcohol. Allow the sensor, clip, and cable to dry thoroughly before use.

Cleaning the AccuVet SpO₂ Reflectance Sensor



CAUTION: Do not sterilize by irradiation, steam, or ethylene oxide.

Clean the sensor before and after each use making sure to remove all bioburden. The sensor may be surface-cleaned by wiping it with a soft cloth saturated with a solution such as 70% isopropyl alcohol. If low level disinfection is required, use or 10% (1:10) solution of chlorine bleach and tap water. Do not use undiluted bleach (5%-25% sodium hypochlorite) because permanent damage to the sensor could occur. To clean or disinfect the sensor:

1. Saturate a clean, dry gauze pad or soft cloth with the cleaning solution. Wipe all surfaces of the sensor with the gauze pad.
2. Saturate another clean, dry gauze pad or soft cloth with sterile or distilled water. Wipe all surfaces of the sensor with the gauze pad.
3. Allow the sensor and cable to dry thoroughly before use.

Cleaning the AccuVet SpO₂ Extension Cable

Clean the connecting cable with warm soapy water or 70% isopropyl alcohol. Allow the cable to dry thoroughly before use.

10.3 Preventative Maintenance



WARNING: Do not disassemble the unit. There are no user serviceable parts except for the battery. Refer to qualified service personnel.

System Self Checks

The Vet30 performs a range of system checks during normal operation. If the monitor detects a problem, it will display a status message recommending a troubleshooting action or to contact SunTech Customer Service.

Replaceable Parts



CAUTION: Replace user replaceable parts that are broken, worn, missing, damaged, incomplete, or contaminated. Contact SunTech Medical for service on parts that are not user replaceable and stop using device until repaired. Failure to repair a damaged product may cause injury to the user and/or patient.

On a routine basis, inspect the monitor, cuffs, sensors, and hoses for cracks, fraying, or kinks. Immediately replace any damaged part. Device can function without a battery. However, if battery fails to maintain a charge, replace the battery. Before replacing the battery, make sure the device is turned off and disconnected from patient. Do not replace the battery without removing power supply from wall. The start/stop button does not remove power from the system. To replace the battery, use a screwdriver to unscrew the screw and open the battery bay door on the bottom of the device. Remove battery by disconnecting the electrical connector. Replace battery and reconnect the electrical connector. Replace battery bay door and secure with screw. Before use, battery must be fully charged.

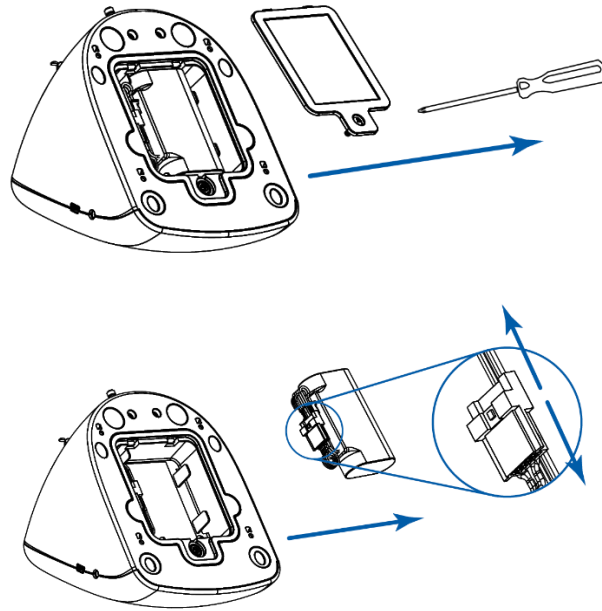

CAUTION: Use only approved accessories. Replace battery only with SunTech part number 17-0026-00.

Expected Service Life

Monitor: 7 years (dependent upon internal BP pump usage)

AccuVet SpO₂ sensor: 3 years

Masimo Patient Cable: 17,520 hours of patient monitoring time

AccuVet temperature probe: 3 years

Lithium-ion Battery: 250 cycles (before capacity falls below 80% of original capacity)

10.4 System Components

Your Vet30 System should contain the following items.

	Standard Qty.
Vet30 System	
Vet30 System Monitor	1
Patient Hose, 6ft (1.8m)	1
Vet System Cuff Kit (6 cuffs)	1
Vet30 Quickstart Guide	1
AccuVet Y-lingual SpO ₂ Sensor with 2 clips	1
- OR -	
Masimo LNCS YI AH SpO ₂ Sensor with 3 clips	
AccuVet Temperature Probe	1
AC Adapter, Universal	1
Protective Armour	1
USB Bluetooth Transmitter	1

10.5 Accessories & Replacement Parts

Contact your sales representative to purchase the following items:

Description	Part Number	Details
#1 Cuff	98-0400-80-VET	3 – 6 cm, white, non-locking, box of 20
#2 Cuff	98-0400-81-VET	4 – 8 cm, white, non-locking, box of 20
#3 Cuff	98-0400-82-VET	6 – 11 cm, white, non-locking, box of 20
#4 Cuff	98-0400-83-VET	7 – 13 cm, white, non-locking, box of 20
#5 Cuff	98-0400-84-VET	8 – 15 cm, white, non-locking, box of 20
#6 Cuff	98-0400-F1	12 – 19 cm, white, non-locking, box of 20
#7 Cuff	98-0400-F3	17 – 25 cm, white, non-locking, box of 20
Vet Cuff Pack, Slip Luer, Sizes #1-6	98-0240-00	Pack of 6 cuffs: 1 of each size 1-6
Patient Hose, 6 ft (1.8 m)	91-0028-75	6 ft (1.8 m), black, individual
Patient Hose, 10 ft (3 m)	91-0028-76	10 ft (3 m), black, individual
AC Adapter	19-0020-00	Power Supply, Universal
Armour in Flamingo Pink	39-0195-03	Protective cover, pink, individual
Armour in Peacock Blue	39-0195-04	Protective cover, blue, individual
Armour in Tree Frog Green	39-0195-02	Protective cover, green, individual
AccuVet Y-lingual SpO ₂ Sensor w/ 2 clips	52-0019-00	Y-lingual sensor, 6.5 ft (2 m)
AccuVet SpO ₂ Reflectance Sensor	52-0020-00	Rectal sensor, 5.9 ft (1.8 m)
AccuVet SpO ₂ Extension Cable	52-0021-00	Extension cable, 6.5 ft (2 m)
AccuVet Temperature Probe, 2m	52-0022-00	Temperature probe, 6.5 ft (2 m)
AccuVet Temperature Probe, 3m	52-0023-00	Temperature probe, 9.8 ft (3 m)
Masimo LNCS™ YI AH SpO ₂ w/ 3 clips	52-0031-00	Y-lingual sensor, 3 ft (0.9 m)
Masimo LNCS TF-I AH Transflectance SpO ₂ Sensor	52-0031-02	Reflectance sensor, 3 ft (0.9 m)
Masimo LNC Patient Cable	52-0031-01	Patient cable, 10 ft (3 m)
Masimo AH SpO ₂ Replacement Clips (3)	52-0025-00	Pack of 3 sizes (small, medium, large)
Rechargeable Lithium-Ion Battery	17-0026-00	7.2 V, 2.2 Ah, 15.8 Wh
Carrying Case	45-0010-00	Nylon bag that fits monitor and accessories
USB Bluetooth Transmitter	45-0008-00	

10.6 Status Messages

If the SunTech Vet30 has a problem performing a task, a short beep will occur (if speakers are ON), the START/STOP button will turn Red and a Status Message will appear on the monitor screen. Take action as directed on the screen, or as suggested in the table below.

Status Message	Reason	Solution
Air Leak	There is a leak in the cuff, hose or monitor. Also possible if cuff or hose is not attached to the monitor.	Check that the hose is connected to the monitor and cuff. Check that the cuff is properly tightened. Check that the cuff is in the correct position. Check that the cuff is not leaking air. Check that the hose connections are not damaged or loose.
Value out of Range	The blood pressure value is outside of SunTech Vet30's published ranges.	Make sure you are using the proper cuff size. Patient may have been moving too much. Check that the cuff is properly tightened and in proper position.
Poor Signal Quality	Monitor is not receiving a strong signal from patient. Also possible if a rapid deflation occurs during a measurement.	Check that cuff is in correct position. Check the patient. Check that cuff is properly tightened. Check that correct size cuff is used.
Artifact Detected	Monitor is picking up on unexpected noise or movements.	Check animal mode. It might be on wrong setting. Check patient for motion, trembling. Too much movement. Check that cuff is in correct position. Check that correct size cuff is used.
Measurement Too Long	The monitor is not detecting strong and consistent signals from the patient for an extended time period.	Check to ensure cuff is fitting snugly on patient and is positioned properly. Check that cuff is in correct position. Check patient for moving, trembling.
Check Batteries!	Battery power is low.	See the battery life indicator on the Main Screen. Recharge or replace battery as needed.
Air Blockage	Air is not able to pass through the hose or cuff properly.	Check that hose has no sharp bends and is not pinched. Check that patient is not lying or stepping on cuff. Check that cuff is in correct position.
Cuff Overpressure	Pressure in the cuff briefly exceeded 300 mmHg due to patient movement, air blockage or using a cuff that is too small.	Check that correct size cuff is being used. Check that hose has no sharp bends and is not pinched. Check that patient is not lying or stepping on cuff. Ensure patient is not moving excessively.
Monitor Not Ready	Monitor is preparing for next measurement or may need service.	Touch START/STOP to start a new measurement. For repeated errors, calibration or service may be required.
System Failure	A monitor system has failed.	Service is required.
Error!	Connection with the Bluetooth pairing device failed.	Check to ensure that the device is within range (30 feet) of the pairing device.

		Check that the pairing device has Bluetooth turned on and is advertising.
Transfer Error	Bluetooth paired device became disconnected.	Check to ensure that the device is within range (30 feet) of the pairing device. Check that the pairing device has Bluetooth turned on and is advertising.

10.7 SpO₂ Status Messages

If the SunTech Vet30 encounters a problem related to the Masimo SpO₂ functionality, a warning sign will appear on the main screen. Touch the warning symbol to open the SpO₂ focus screen, where further information will be available about what went wrong. Take action as directed on the screen, or as suggested in the table below.

Status Message	Reason	Solution
No Sensor Connected	SpO ₂ sensor is not fully inserted into the Vet30 or not fully connected to the cable. May be an incorrect sensor or a defective sensor or cable.	Disconnect and reconnect sensor into the cable or into the Vet30. Check to see if the sensor LED is flashing. Disconnect and reconnect the sensor. If the LED fails to operate, replace the sensor
Replace Sensor	The SpO ₂ sensor is non-functional or defective.	Replace the SpO ₂ sensor.
Low Perfusion Index	Signal strength is too weak.	Move sensor to better perfused site.
Pulse Search	Device is searching for a pulse.	If device fails to display within 30 seconds, disconnect and reconnect. If pulse search continues, move sensor to better perfused site.
Interference Detected	High intensity light (pulsating strobe lights, excessive ambient light sources such as surgical lights or direct sunlight) or other monitor displays are interfering with the sensing.	Place a light shield over the sensor to block the interference.
Sensor Off Patient	Sensor not connected to patient properly. Also possible if sensor is damaged.	Properly reapply the sensor to the patient and reconnect the sensor to the device or patient cable. If the sensor is damaged, replace the sensor.
Too Much Ambient Light	High intensity light (pulsating strobe lights, excessive ambient light sources such as surgical lights or direct sunlight) or other monitor displays are interfering with the sensing.	Place a light shield over the sensor to block the interference.
Incompatible Sensor	SpO ₂ sensor in use is not compatible with the device.	Use a compatible sensor.
Low SpO ₂ Signal IQ	Indicates low signal confidence of the acquired SpO ₂ signal.	Ensure proper sensor application. Minimize patient movement.

		Move sensor to a better perfused site.
Masimo SET Processing Active	Indicates Masimo SET technology is actively acquiring a signal.	No action necessary. This is expected during SpO ₂ signal acquisition.
No Cable Connected	The SpO ₂ cable is not attached or not fully inserted into the Vet30.	Disconnect and reconnect the cable.
No Adhesive Sensor Connected	When a single-patient-use sensor is used, the adhesive portion of the sensor is not connected.	Ensure the adhesive portion is firmly connected to the sensor.
Demo Mode	Demo Mode is triggered when an optional Demo Tool (available from Masimo only) is plugged into the unit.	Use SpO ₂ sensor provided with the system during procedures.
Monitor Not Ready – SpO ₂	Monitor is preparing to take measurements or may need service.	Check that the SpO ₂ sensor is fully plugged into the back of the Vet30. Check that the sensor is properly applied to the patient. If error continues, service or a sensor replacement may be required.
Loss of Communications	Sensor is disconnected during use or system communications failure.	Check that the SpO ₂ sensor is fully plugged into the back of the Vet30. If error continues, service or a sensor replacement may be required.

11. Frequently Asked Questions

How many measurements can I store in Memory?

You can store up to 960 measurements. The monitor has a revolving memory. When you take your 961st measurement, it will be listed as measurement #1.

How do I delete data from memory?

Select the Memory button and touch the Delete button. Before the memory is cleared, you will be asked to confirm or cancel the deletion. When you clear the Memory, you delete all measurements for all parameters.

For medium-sized dogs, which animal mode do I choose?

Use cuff size as the determination factor. If a #3 cuff or smaller is the best fit, choose small animal mode. If #4 or larger, choose large animal mode.

How do I choose the correct cuff size?

Wrap the cuff around the patient's limb and make sure the index line falls within the range marker. If two different cuff sizes fit the patient, choose the larger size.

How long will the battery last?

During continuous monitoring of SpO₂ and temperature, with an Interval BP set for every 5 minutes, a fully charged battery should last at least 4 hours before requiring recharging. If only taking manual BP measurements, a fully charged battery should last for at least 150 BP measurements before requiring recharging. Fully charging the battery should take under 6 hours. Battery life is very dependent on the touch screen display ON time. To maximize life, SunTech suggests setting the Auto OFF timer to 5 minutes.

Can I use this monitor on awake and anesthetized animals?

Yes. The Vet30 can be used on anesthetized animals as well as awake animals.

How do I keep the cuff from slipping down the limb or coming off?

Attach the cuff as tight as possible. Extra attention will be needed on species with dense or thick fur. If the cuff will not stay attached, check the hook & loop for fur and remove if possible.

Are there other power options?

Yes. The device is provided with a mains power supply that recharges the internal battery when connected. When the monitor is not connected to the power supply, the battery will allow the unit to be portable for use.

What are the minimum and maximum cat & dog weights when taking measurements with the Vet30?

There are none. Any cat or dog that has a limb that fits within the cuff ranges is acceptable.

12. Limited Warranty

SunTech Medical, Inc. provides to the original purchaser the following limited warranty from date of invoice.

Monitors	24 months
Cuffs/Hoses	90 days
Masimo Accessories	6 months
AccuVet Accessories	1 year

SunTech Medical, Inc. warrants each instrument to be free from defects in material and workmanship. Liability under this warranty covers servicing of the instrument when returned from the customer’s facility within the United States prepaid to the factory. SunTech Medical, Inc. will repair any component(s) or part(s) that it finds to be defective during the period of this limited warranty. Should a defect become apparent, the original purchaser should first notify SunTech Medical, Inc. of the suspected defect. The instrument should be carefully packaged and shipped prepaid to:



SunTech Medical, Inc.
Service Department
5827 S Miami Blvd, Suite 100
Morrisville, NC 27560 USA

Tel: 800.421.8626
919.654.2300
Fax: 919.654.2301

This limited warranty is void if the instrument has been damaged by accident, misuse, negligence, act of God or serviced by any person not authorized by SunTech Medical, Inc. It contains the entire obligation of SunTech Medical, Inc. and no other warranties expressed, implied or statutory are given. No representative or employee of SunTech Medical, Inc. is authorized to assume any further liability or grant any further warranties except as herein.

13. Technical Information

13.1 Monitor Model Numbers

Part Number	Model Number	Model Description
99-0171-00	M30A	Vet30 with AccuVet SpO ₂ , Flamingo Pink Armour
99-0171-01	M30A	Vet30 with AccuVet SpO ₂ , Peacock Blue Armour
99-0171-02	M30A	Vet30 with AccuVet SpO ₂ , Tree Frog Green Armour

99-0172-00	M30B	Vet30 with Masimo SpO ₂ , Flamingo Pink Armour
99-0172-01	M30B	Vet30 with Masimo SpO ₂ , Peacock Blue Armour
99-0172-02	M30B	Vet30 with Masimo SpO ₂ , Tree Frog Green Armour

13.2 Factory Default Settings

Parameter Name	Default Value
Clinical Alarms Status	OFF
Clinical Alarms – low SYS	40 mmHg
Clinical Alarms – High SYS	265 mmHg
Clinical Alarms – low DIA	20 mmHg
Clinical Alarms – High DIA	200 mmHg
Clinical Alarms – low MAP	27 mmHg
Clinical Alarms – High MAP	222 mmHg
Clinical Alarms – low HR	25 bpm
Clinical Alarms – High HR	300 bpm
Clinical Alarms – Low Temp	32°F (°C)
Clinical Alarms – High Temp	122°F (°C)
Clinical Alarms – Low SpO ₂	70%
Clinical Alarms – High SpO ₂	100%
Speaker Status	OFF
Auto OFF Timer	10 minutes
Interval BP Rate	3 minutes
Language	English
Startup Animal Selection	ON
Date Format	MM/DD/YYYY
Time Format	12-hour
Bluetooth Status	OFF

13.3 Performance Specifications



CAUTION: Performance can be affected if used or stored outside the specified temperature and humidity ranges.

Operating Conditions:	0°C to 40°C, 15% to 90% non-condensing humidity
Storage Conditions:	-20°C to 65°C, 15% to 90% non-condensing humidity
Altitude:	Measurement accuracy not affected by altitude
Power Source:	Lithium-ion Battery and/or AC Adapter
Input Voltage Range:	Universal (100 to 240 Vac)
Input Frequency Range:	50/60 Hz
Input Efficiency rating:	DoE Level VI
Isolation Classification:	Class II
Output Voltage:	12 Vdc
Output Current:	0 to 2.5 A
Protection from electrical shock:	Class 2
Duty Cycle:	Continuous use
Battery:	7.2 V, 2.2 Ah, 15.8 Wh
Dimensions:	6.25" x 5" x 5.25" (15.9cm x 12.7cm x 13.3cm)
Weight:	M30A: 2.35 lbs (1.1 kg) with battery and sensors M30B: 2.65 lbs (1.2 kg) with battery and sensors

BP Specifications

Method of Measurement:	Oscillometric
Blood Pressure Range:	Systolic: 40 – 265mmHg MAP: 27 – 222mmHg Diastolic: 20 – 200mmHg
Pulse Rate Range:	25 to 300 BPM (Beats Per Minute)
Pulse Rate Units:	Beats per minute
Cuff Deflate Rate:	Deflation step size varies with heart rate, cuff pressure and cuff volume
Initial Inflation Pressure:	180 mmHg (default)
Subsequent initial inflation:	previous Systolic + 30 mmHg
Transducer Accuracy:	±3 mmHg between 0 mmHg and 300 mmHg
Transducer Calibration:	Recommended bi-annually or if a calibration problem is suspected

Temperature Specifications

Temperature Range:	26°C to 46°C
Temperature Accuracy:	±0.3°C plus the temperature sensor tolerance
Temperature Resolution:	0.1°C
Sensor:	YSI 400 compatible
Display Update Rate:	1 Hz
Measurement Mode:	Direct measurement
Transient Measurement Time:	45 seconds

Masimo Pulse Oximetry Specifications

Accuracy specifications are statistically distributed, and only about two-thirds of the measurements fall within the 1 Std. Dev. specification.

	LNCS YI Multisite Sensor	LNCS TF-I Reflectance Sensor
SpO ₂ Range	0-100%	0-100%
SpO ₂ Accuracy	±2% at 70%-100%, for patients weighing >30 kg Undefined, for patients weighing <30 kg	±2% at 70%-100%, for patients weighing >30 kg Undefined, for patients weighing <30 kg

Pulse Rate Range	25-240 BPM	25-240 BPM
Pulse Rate Accuracy	±3 BPM, for patients weighing >30 kg Undefined, for patients weighing <30 kg	±3 BPM, for patients weighing >30 kg Undefined, for patients weighing <30 kg

SpO₂ Averaging Time: 8 second averaging

TF-I Sensor Wavelength: Red 660nm
Infrared 880nm

Ingress Protection: IPX1

AccuVet Pulse Oximetry Specifications

SpO₂ Range: 0-99%

SpO₂ Accuracy: ±2% at 70%-99%
<70% unspecified

SpO₂ Resolution: 1% increments

SpO₂ Averaging: 8 pulse beat average

Calibration: Factory calibrated over the range of 70% to 99% SpO₂ using human blood samples to functional saturation. Test methods available upon request. No in-service calibration is required.

Sensor Wavelength: Red 660nm, 2mW (typical)
Infrared 905nm, 2-2.4mW (typical)

Display Update Rate: 1 Hz (maximum age of SpO₂ and pulse rate data is 35 seconds)

Pulse Oximetry Units: % SpO₂

Pulse Rate Range: 18-400 BPM

Pulse Rate Resolution: 1 BPM

Pulse Rate Units: Beats per minute

Pulse Rate Accuracy: ±2% or 2 BPM, whichever is greater

Pulse Rate Averaging: 8 second average

Ingress Protection: IPX1

AccuVet Reflectance Sensor Specifications

SpO₂ Range: 50-100%

SpO₂ Accuracy: ±1% at 70%-100%
±2% at 50%-69%

SpO₂ Resolution: 1% increments

Ingress Protection: IPX1

13.4 Radio Frequency Compliance Requirements

This device contains a transmitter module identified by FCC ID: QOQBGM111 and Industry Canada: IC 5123A-BGM111. It has been tested and found to comply with the limits for a Class B device. Changes or modifications not expressly approved by the manufacturer could void the user's authority to operate the equipment. This device complies with Part 15 of the FCC Rules for the United States. Operation is subject to the following 2 conditions:

- 1) This device may not cause interference; and
- 2) This device must accept any interference, including interference that may cause undesired operation of the device.

Radio Equipment Directive (RED)

This is a Class I device that contains a wireless transmitter which can be used in at least one EU member state. There are no restrictions of use.

13.5 Electromagnetic Compatibility (EMC)

Changes or modifications to the SunTech Vet30 that are not approved by SunTech Medical may cause EMC interference problems with this or other equipment.

EMC Statement

This equipment needs special precautions regarding EMC and needs to be installed and put into service per the EMC information provided in this document. This equipment has been tested and found to comply with the limits for medical devices to IEC60601-1-2: 2014. These limits are designed to provide reasonable protection against harmful interference in a typical medical installation. This equipment generates, uses and can radiate radio frequency energy and, if not installed and used in accordance with the instructions, may cause harmful interference to other devices in the vicinity. However, there is no guarantee that interference will not occur in a particular installation. If this equipment does cause harmful interference to other devices, which can be determined by turning the equipment off and on, the user is encouraged to try to correct the interference by one or more of the following measures:

- Reorient or relocate the receiving device.
- Increase the separation between the equipment.
- Connect the equipment into an outlet on a circuit different from which the other device(s) are connected.
- Consult the manufacturer or field service technician for help.
- Portable and mobile RF communications equipment can affect Medical Electrical Equipment.



WARNING: Portable RF communications equipment (including peripherals such as antenna cables and external antennas) should be used no closer than 30 cm (12 inches) to any part of the Vet30 system, including cables specified by the manufacturer. Otherwise, degradation of the performance of this equipment could result.

WARNING: Use of accessories, transducers, and cables other than those specified may result in increased emissions or decreased immunity of the Vet30.

WARNING: The Vet30 should not be used adjacent to or stacked with other equipment. If adjacent or stacked use is necessary, the Vet30 should be observed to verify normal operation in the configuration in which it will be used.

WARNING: This equipment/system is intended for use by healthcare professionals only. This equipment/ system may cause radio interference or may disrupt the operation of nearby equipment. It may be necessary to take mitigation measures, such as re-orienting or relocating the Vet30 or shielding the location.

Guidance and Manufacturer's Declaration – Electromagnetic Emissions

The Vet30 Monitor is intended for use in a Professional Healthcare Facility within the electromagnetic environment specified below. The customer or the user of the Vet30 Monitor should assure that it is used in such an environment. This equipment has been tested and found to comply with the limits for medical devices to IEC60601-1-2: 2014.

Emissions test	Compliance	Electromagnetic Environment – Guidance
RF emissions CISPR 11	Group 1	The Vet30 Monitor uses RF energy only for its internal function. Therefore, its RF emissions are very low and are not likely to cause any interference in nearby electronic equipment.
	Class B	The Vet30 Monitor is suitable for use in all establishments other than
Harmonic emissions IEC 61000-3-2	Class A	

Guidance and Manufacturer's Declaration – Electromagnetic Emissions

Voltage fluctuations/ flicker emissions IEC 61000-3-3	Complies	domestic and those directly connected to the public low-voltage power supply network that supplies buildings used for domestic purposes.
---	----------	--

Guidance and Manufacturer's Declaration – Electromagnetic Immunity

The Vet30 Monitor is intended for use in a Professional Healthcare Facility within the electromagnetic environment specified below. It is not intended for helicopter transport, hospital ambulance or home use. It is not intended for near active HF SURGICAL EQUIPMENT and the RF shielded room of an ME SYSTEM for magnetic resonance imaging, where the intensity of EM DISTURBANCE is high. The customer or the user of the monitor should assure that it is used in such an environment. This equipment has been tested and found to comply with the limits for medical devices to IEC 60601-1-2: 2014.

Immunity Test	Applies to	Compliance Level	Electromagnetic Environment-Guidance for Professional Healthcare Facility Environment
Electrostatic discharge (ESD) IEC 61000-4-2	All device input and output connections and cables	± 2, 4, 6, 8kV contact ± 2, 4, 8, 15kV air discharge	Floors should be wood, concrete or ceramic tile. If floor are covered with synthetic material, the relative humidity should be at least 30%. Users must eliminate static in their hands before use it.
Radiated RF EM fields IEC 61000-4-3	All device input and output connections and cables	3V/m 80 MHz to 2700MHz 80% AM at 1kHz	Radiated electromagnetic fields should be at levels characteristic of a typical location in a typical commercial or hospital environment
Radiated RF Wireless communication equipment IEC 61000-4-3	All device input and output connections and cables	See Table A below	This device has been subjected to RF wireless communication bands from cell phones, and other communication devices
Electrical fast transient/burst IEC 61000-4-4	All device input and output connections and cables	± 2kV for power supply lines 100kHz repetition frequency	Mains power quality should be that of a typical commercial or hospital environment (Professional Healthcare Facility)
Surge IEC 61000-4-5	AC Mains to Line to Ground	± 0.5, 1, 2kV	
	AC Mains to Line to Line	± 0.5, 1kV	
	DC Input (>3m), Line to Ground	± 0.5, 1, 2kV	DC power quality shall be provided by the supplied power adapter

Guidance and Manufacturer's Declaration – Electromagnetic Immunity

	DC Input (>3m), Line to Ground	± 0.5, 1kV	
Conducted Disturbances induced by RF fields IEC 61000-4-6	All device input and output connections and cables	3V 0.15MHz – 80MHz 6V in ISM bands between 0,15 MHz and 80MHz 80% AM at 1kHz	Mains power quality should be that of a typical commercial or hospital environment. All handheld and patient coupled parts should be consistent with intended use.
Power Frequency (50Hz) magnetic field IEC 61000-4-8	All device input and output connections and cables	30A/m	Power Frequency magnetic fields should be at levels characteristic of a typical location in a typical commercial or hospital environment.
Voltage dips, short interruptions and voltage variations on power supply input lines IEC 61000-4-11	Device input (AC power)	<5% UT (>95% dip in UT) for 0.5 cycles 40% UT (60% dip in UT) for 5 cycles 70% UT (30% dip in UT) for 25 cycles <5% UT (>95% dip in UT) for 5 sec	Mains power quality should be that of a typical commercial or hospital environment (Professional Healthcare Facility) If the user of the monitor requires continued operation during power mains interruption, it is recommended that the monitor be powered from an uninterruptible power supply or a battery.
NOTE: <i>UT is the a.c. mains voltage prior to application of the test level</i>			
Conducted RF IEC 61000-4-6	All device input and output connections and cables	3V 10V ISM bands 150kHz to 80MHz	Portable and mobile RF communications equipment should be used no closer to any part of the monitor including cables, than the recommended separation distance calculated from the equation applicable to the frequency of the transmitter. Minimum separation distance for higher IMMUNITY TEST LEVELS shall be calculated using the following equation. Where P is the maximum output power rating of the transmitter in watts (W) according to the transmitter manufacturer and d is the recommended separation distance in meters (m) and E is the Immunity Test Level in V/m.
			$E = \frac{6}{d} \sqrt{P}$

Guidance and Manufacturer's Declaration – Electromagnetic Immunity

			Field strengths from fixed RF transmitters, as determined by an electromagnetic site survey, a should be less than the compliance level in each frequency range
--	--	--	---

Rated maximum output power of transmitter. Watts (W)	Separation distance according to frequency of transmitter meters (m)		
	150 kHz to 80 MHz $d = 1,2\sqrt{P}$	80 MHz to 800 MHz $d = 1,2\sqrt{P}$	800 MHz to 2,5 GHz $d = 2,3\sqrt{P}$
0.01	0.12	0.12	0.23
0.1	0.38	0.38	0.73
1	1.2	1.2	2.3
10	3.8	3.8	7.3
100	12	12	23

For transmitters rated at a maximum output power not listed above, the recommended separation distance d in meters (m) can be estimated using the equation applicable to the frequency of the transmitter, where P is the maximum output power rating of the transmitter in watts (W) according to the transmitter manufacturer.

NOTE 1: at 80 MHz and 800 MHz, the separation distance for the higher frequency range applies.

NOTE 2: These guidelines may not apply in all situations. Electromagnetic propagation is affected by absorption and reflection from structures, objects and people.

a) Field strengths from fixed transmitters, such as base stations for radio (cellular/cordless) telephones and land mobile radios, amateur radio, AM and FM radio broadcast and TV broadcast cannot be predicted theoretically with accuracy. To assess the electromagnetic environment due to fixed RF transmitters, an electromagnetic site survey should be considered. If the measured field strength in the location in which the monitor is used exceeds the applicable RF compliance level above, the monitor should be observed to verify normal operation. If abnormal performance is observed, additional measures may be necessary, such as reorienting or relocating the monitor.

b) Over the frequency range 150kHz to 80 MHz, field strengths should be less than 3V/m

Table A – Test specifications for the device's Signal Input Parts/Signal Output parts to RF wireless communication equipment.

Test Frequency (MHz)	Band a) (MHz)	Service b)	Modulation b)	Maximum Power (W)	Distance (m)	IMMUNITY TEST LEVEL (V/m)
358	380 – 390	TETRA 400	Pulse Modulation b) 18Hz	1,8	0.3	27
450	430 – 470	GMRS 460, FRS 460	FM c) 5 kHz deviation 1 kHz sine	2	0.3	28
710	704 - 787	LTE Band 13, 17	Pulse Modulation b) 217Hz	0,2	0.3	9
745						
780						

810	800 - 960	GSM 800/900, TETRA 800, iDEN 820, CDMA 850, LTE Band 5	Pulse Modulation b) 18Hz	2	0.3	28
870						
930						
1720	1700 - 1990	GSM 1800, CDMA 1900, GSM 1900, DECT, LTE Band 1, 3, 4, 25, UMTS	Pulse Modulation b) 217Hz	2	0.3	28
1845						
1970						
2450	2400 - 2570	Bluetooth, WLAN, 802.11 b/g/n, RFID 2450, LTE Band 7	Pulse Modulation b) 217Hz	2	0.3	28
5240	5100 - 5800	WLAN 802.11 a/n	Pulse Modulation b) 217Hz	2	0.3	9
5500						
5785						
NOTE If necessary to achieve the IMMUNITY TEST LEVEL, the distance between the transmitting antenna and the ME EQUIPMENT or ME SYSTEM may be reduced to 1m. The 1m test distance is permitted by IEC 61000-4-3						
a) For some services, only the uplink frequencies are included b) The carrier shall be modulated using a 50% duty cycle square wave signal c) As an alternative to FM modulation, 50% pulse modulation at 18 Hz may be used because while it does not represent actual modulation, it would be worst case.						

Appendix A: Service Screens



WARNING: Do not disassemble the unit. There are no user serviceable parts except for the battery. Refer to qualified service personnel.

WARNING: The USB port is only a service port and cannot be used to download data or interface with the monitor. When updating the software, the monitor cannot be in use and the accessories should not be contacting the patient.



CAUTION: DO NOT remove unit covers. Doing so may increase the risk of electrical shock. This monitor does not contain any user serviceable parts. Substitution of a component or accessory different from that supplied may result in measurement error. Repairs should be undertaken only by personnel trained or authorized by SunTech Medical. The SunTech Vet30 BP monitor includes a service mode where service information can be accessed, factory default settings can be restored and hardware verification checks can be performed. The service screens are accessed by holding down the power button for approximately 6 seconds when turning the monitor ON. When viewing service screens, the Start/Stop button LED is white.

No parts on the monitor or its accessories are serviceable.

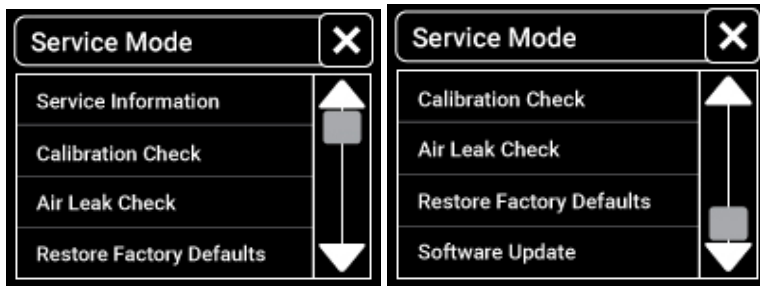

Service Information

Basic details are logged which includes the number of measurement cycles, user interface firmware version, both firmware versions for the BP algorithm as well as a count for each status message. Status codes are provided to assist in troubleshooting during a service call. The image below is provided for example only.

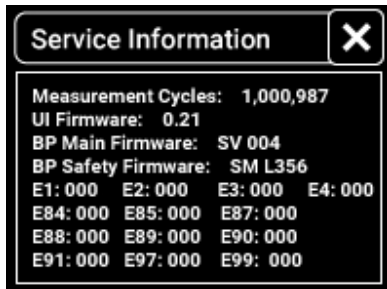

Calibration Check

The pressure transducer in the SunTech Vet30 BP monitor is designed to hold its calibration for many years. Human NIBP devices require that the maximum static pressure accuracy shall be $\pm 3\text{mmHg}$ or 2% of the reading, whichever is greater. This is a stringent requirement and all test equipment must be in excellent working order to properly perform this test. If you do not have access to this equipment or prefer to have someone else verify the calibration, the monitor can be sent to SunTech following the procedure described in the Limited Warranty section of this manual. There may be a charge associated with the verification if the transducer is not out of calibration. SunTech suggests this check be performed every 2 years or if there is suspicion that the monitor may be out of calibration.

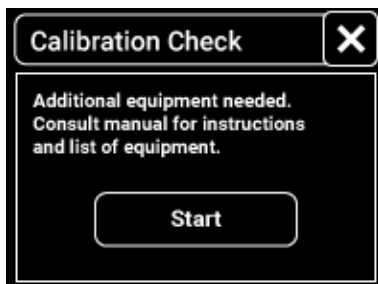

Equipment Needed

- Calibrated Manometer
- Pneumatic "T" Adapters
- Volume (500mL bottle or #6 or #7 cuff wrapped tightly around a solid object)
- Hand Bulb
- Connection Tubing

Procedure

Connect a manometer, volume and the hand bulb to the end of the monitor hose using "T" adapters and connection tubing.

Touch the Start button which closes the valves and shows the pneumatic pressure.

Apply various pressures (between 0 mmHg and 250 mmHg) to the monitor with the hand bulb. INFLATE SLOWLY when adding pressure over 200 mmHg to avoid an overpressure. Verify that the module pressure is equal to the manometer pressure (± 3 mmHg or 2% of the target value).

If the pressure is within limits, then touch the Stop button and the calibration check is complete.

If the pressure does not agree with the manometer, then the transducer needs to be re-calibrated. Send monitor back to SunTech Medical following the procedure in the Limited Warranty section of the manual.

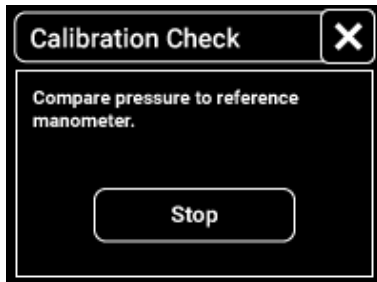

Air Leak Check

International standards for human NIBP devices require that air leakage within the pneumatic system must not exceed 6 mmHg/min. During manufacturing at SunTech Medical, acceptable air leakage is less than 3 mmHg/min. Both of these pass criteria will not affect the performance or accuracy of the NIBP module so the SunTech Vet30 uses the 6 mmHg/min pass criteria. If you do not have access to this equipment or prefer to have someone else perform the air leak check, the monitor can be sent to SunTech following the procedure described in the Limited Warranty section of this manual. There may be a charge associated with performing an air leak check. SunTech suggests this check be performed if there is suspicion of an air leak.



Equipment Needed

Volume (500mL bottle or #6 or #7 cuff wrapped tightly around a solid object)

Standard patient hose

TIP: A reduction in cuff pressure is expected during the first 60 seconds due to pneumatic expansion of the cuff, patient hose and internal tubing. Make sure cuff is wrapped tightly around a solid object. Do not perform with cuff on a patient, lying flat or wrapped loosely.

Procedure

Connect the volume to the monitor patient hose.

Touch the Start button which begins the air leak check and shows the pneumatic pressure and a timer. This check takes approximately 2 minutes.

When the check is complete, the monitor will indicate a pass or fail result.

If pass, then touch the Pass button and the air leak check is complete.

If fail, then there is an air leak within the pneumatic system. Try repeating the check with a different cuff making sure all connections are sealed. If it still fails, you may send the monitor and cuffs back to SunTech Medical following the procedure in the Limited Warranty section of the manual.



Restore Factory Defaults

Factory defaults are restored by accessing this screen. A list of factory default settings is in the Technical Information section of this manual.



Software Update

The software can be updated using a SunTech-provided USB drive.

Procedure



WARNING: When updating the software, the monitor cannot be in use and the accessories should not be contacting the patient.

With the USB drive inserted into the device, touch Software Update from the Service Mode screen. A status bar will indicate the progress of the update. Do not turn off the device during the update. The device will restart when OK is pressed after the update is complete.

