



# GIMA

PROFESSIONAL MEDICAL PRODUCTS

**LARINGOSCOPI CONVENZIONALI  
CONVENTIONAL LARYNGOSCOPES  
LARYNGOSCOPES CONVENTIONNELS  
KONVENTIONELLE LARYNGOSKOPE  
LARINGOSCOPIOS CONVENCIONALES  
LARINGOSCÓPIOS TRADICIONAIS  
LARYNGOSKOPIY KONWENCJONALNE  
LARINGOSCOAPE CONVENȚIONALE  
ΣΥΜΒΑΤΙΚΑ ΛΑΡΥΓΓΟΣΚΟΠΙΑ**

## منظار الحنجرة التقليدي

È necessario segnalare qualsiasi incidente grave verificatosi in relazione al dispositivo medico da noi fornito al fabbricante e all'autorità competente dello Stato membro in cui si ha sede.

All serious accidents concerning the medical device supplied by us must be reported to the manufacturer and competent authority of the member state where your registered office is located.

Il est nécessaire de signaler tout accident grave survenu et lié au dispositif médical que nous avons livré au fabricant et à l'autorité compétente de l'état membre où on a le siège social.

Jeder schwere Unfall im Zusammenhang mit dem von uns gelieferten medizinischen Gerät muss unbedingt dem Hersteller und der zuständigen Behörde des Mitgliedsstaats, in dem das Gerät verwendet wird, gemeldet werden.

Es necesario informar al fabricante y a la autoridad competente del Estado miembro en el que se encuentra la sede sobre cualquier incidente grave que haya ocurrido en relación con el producto sanitario que le hemos suministrado.

È necessário notificar ao fabricante e às autoridades competentes do Estado-membro onde ele está sediado qualquer acidente grave verificado em relação ao dispositivo médico fornecido por nós.

Należy poinformować producenta i kompetentne władze danego Kraju członkowskiego o każdym poważnym wypadku związanym z wyrobem medycznym naszej produkcji.

Orice accident grav produs, privoritor la dispozitivul medical fabricat de firma noastră, trebuie semnalat producătorului și autorității competente în statul membru pe teritoriul căruia își are sediul utilizatorul.

Σε περίπτωση που διαπιστώσετε οποιοδήποτε σοβαρό περιστατικό σε σχέση με την ιατρική συσκευή που σας παρέχουμε θα πρέπει να το αναφέρετε στον κατασκευαστή και στην αρμόδια αρχή του κράτους μέλους στο οποίο βρίσκειστε.

يجب الإبلاغ فوراً عن أي حادث خطير وقع فيما يتعلق بالجهاز الطبي الذي زدونا به إلى الجهة الصانعة والسلطة المختصة في الدولة العضو التي يقع فيها

**REF** 34301 - 34302 - 34303 - 34305 - 34306 - 34307  
34310 - 34311 - 34312 - 34313 - 34314 - 34317  
34318 - 34319 - 34320 - 34321 - 34352 - 34354



 Gima S.p.A.  
Via Marconi, 1 - 20060 Gessate (MI) Italy  
gima@gimaitaly.com - export@gimaitaly.com  
[www.gimaitaly.com](http://www.gimaitaly.com)  
Made in Pakistan



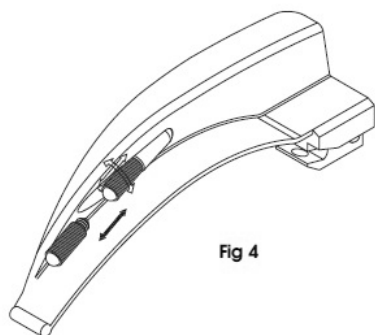
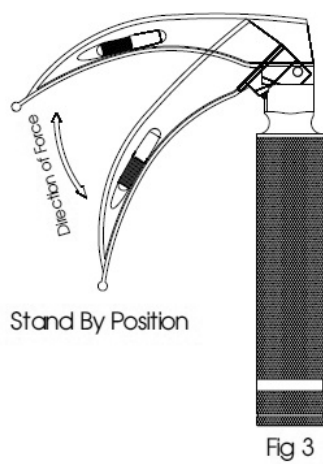
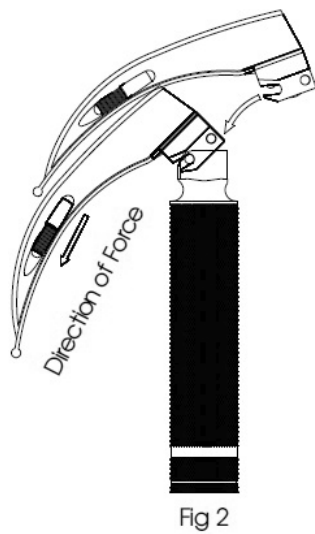
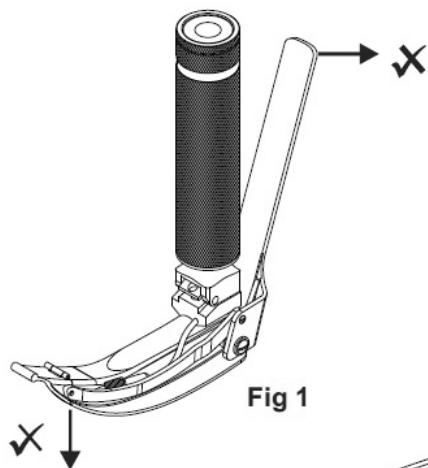

Thank you for purchasing our product. This product meets the most stringent requirements regarding the selection of manufacturing materials and also the final control. These instructions should be followed to ensure durability of this product.

The operator must carefully read and understand this manual thoroughly to keep the product performance durable and reliable for longer period.

After opening the packages, first of all it is necessary to check all the components against the standard configuration. Check that they are all present and in perfect conditions.

## **FEATURES**

The laryngoscope blades are manufactured from antimagnetic 18/8- quality stainless steel type AISI 303/304 which is highly resistant to corrosion and conform to the ISO 7376 standard.

GIMA blades are maintenance free and autoclavable up to 134°C / 5 min approximately for 2,000 times.

## **USING THE BLADES**

Do not grip the lever when removing the blade. Do not apply any pressure, in the directions shown in the illustration Fig 1, which could force the blade and lever apart.

Damage to the linkage may occur, resulting in incorrect action, or stiffness of the adjustable tip. The blade is assembled to the handle in the normal manner. The lever to operate the tip section will then extend behind the handle. The lever should not be touched during the initial stage of use, until the tip of the laryngoscope has been inserted into the vallecula.

Once this stage has been reached, movement of the lever towards the handle will elevate the tip of the blade, and therefore lift the epiglottis, without the need to increase the force exerted by the main part of the blade. Release the lever before the blade.

## **OPERATING INSTRUCTION**

1. Engage the blade by aligning the slot of the blade on to the hook pin of the handle and apply a sufficient force 1N-5N to make engagement as show in Fig 2.
2. Apply force upward to bring the blade in operating position as in Fig 3.
3. To bring the blade in stand by position apply force downward as in Fig 3.

## **LAMP REPLACEMENT PROCEDURE**

1. Unscrew the lamp in counterclock wise direction until free as shown in Fig 4.
2. Replace the lamp and verify that the lamp is sufficiently tightened before use.
3. Be sure that the lamp is properly screwed in.

## **BATTERY REPLACEMENT PROCEDURE**

1. Unscrew bottom cap of handle and remove batteries.
2. For greater longevity, alkaline batteries are recommended as replacement. Ordinary carbonic batteries may also be used.
3. Replace with appropriate size batteries making sure the + and - terminals are placed correctly.
4. In handle insert one positive end down, the other positive end up and reinstall the end cap. If handle light guide fails to light batteries may need to be reversed for correct polarity.

2.5V battery handles can be used with dry batteries as well as 2.5V rechargeable batteries.

## **CARE & MAINTENANCE**

Remove batteries before cleaning, high level disinfecting or sterilization of the laryngoscope system.

### **BLADES**

#### **1. Cleaning Procedure**

Immediately after use, the laryngoscope system should be rinsed under cool running tap water until all visible soil is removed. Ensure that all hard-to-reach areas are flushed with the running tap water. Immerse sealed laryngoscope system in a presoak enzymatic cleaner solution, which was prepared in accordance to manufacturer's recommendations for a minimum of two minutes. Remove device from enzymatic cleaner solution and rinse with lukewarm running tap water for a minimum of one minute to remove all residues and visible soils. Then, immerse device in enzymatic detergent. Remove bottom cap and brush thoroughly using a soft-bristle brush, while ensuring that all hard to reach are reached visible soils / residue removed. Dry with lint free, clean cloth or filtered pressurized air. Follow with HIGH-LEVEL DISINFECTION or STEAM STERILIZATION PROCEDURE.



Ultrasonic cleaning is strictly prohibited.

## 2. Disinfection

Soaking in solutions or Thermo chemically in a washer Sterilizer up to 65°C maximum may perform disinfection. Manufacturer's instructions regarding duration and concentration of solutions should be strictly adhered. After Disinfection, rinse thoroughly in sterile water and dry with a lint free clean cloth.

## 3. Cold Soak Solution

To achieve a high-level disinfection, Cidex®OPA or 2.4% Glutaraldehyde solution may be used according to manufacturer's instructions. Dry with lint free, clean cloth or filtered pressurized air. Reassemble all parts, load handle with batteries and test the system for proper function.

If not functional, review battery / lamp testing instructions below.



Do not immerse Blades in Bleach, Betadine or Potassium Hydroxide solutions.

Doing so will several damage instruments also avoid metal to metal contact after soaking, the blades should be rinsed under sterile water to remove chemical residues and dry with lint free clean cloth or filtered pressurized air.

## 4. Sterilization

Before performing any of the procedures described below, the blade should be cleaned as described in the cleaning Procedure.

## 5. Gas Sterilization

Gas sterilization by Ethylene oxide up to a maximum temperature of 65°C and 8 p.s.i, may be performed, which is preferred especially if sterilization is to be performed regularly.

## 6. Steam Sterilization

Steam Sterilization can also be performed. Insert device in appropriate autoclave pouch.

	(A) GRAVITY DISPLACEMENT STEAM	(B) PRE-VACUUM STEAM
Temperature	121°C (250°F)	134°C (273°F)
Cycle Time	30 Minutes	5 Minutes
Dry Time	15 Minutes	20 Minutes



**Note:** Do not exceed temperature of 135°C and pressure of 28 p.s.i

Flash autoclaving and hot air sterilization should be avoided as these processes will damage the instrument.

## Steris Amsco V-Pro

Laryngoscope Blades and Handles are compatible with:

Amsco V-Pro 1 Low Temperature Sterilization System

Amsco V-Pro 1 Plus Low Temperature Sterilization System

Amsco V-Pro 1 Pro Max Temperature Sterilization System

## Sterrad

Laryngoscope Blades and Handles are compatible with:

Sterrad 100nx System (Standard and Express Cycle)

Sterrad nx System (Standard Cycle)

Sterrad 1005 and 200 System (Short Cycle Outside US)

Sterrad 50 System

## HANDLES

### Cleaning/Sterilization:

Battery Handle withstand the same cold soak solution and autoclave ranges outlined in the blade section. However, the batteries and lamp must be removed prior to disinfection/sterilization.













Battery Handles can withstand exposure to the ethylene oxide. Lamp may be cleaned with cotton ball dampened in alcohol (IPA). The main handle and a cap will also withstand and exposure to ethylene oxide.

 Do not allow excess fluid to seep into electrical contact, batteries must be removed before cleaning & sterilization.

**BLADE & HANDLE TEST PROCEDURE**

Laryngoscope blades and handle should always be tested after cleaning/ disinfection/ sterilization and prior to use. To test connect the laryngoscope blade to handle and pull it to the ON position as in Fig 2 if the unit fails to light or flicker, check the lamp/ batteries and the electrical contacts, Be sure adequate supplies of spare lamps, batteries and replacement parts are readily available if problem still persists, contact supplier please.

 **Warning**  
The above listed sterilization Guidelines, provided by GIMA are intended as procedures compatible with specific materials. Sterilization must be performed to approved Hospital protocol. GIMA can not guarantee sterility. This will be validated by the hospital and or sterilization equipment manufacturers.

	Caution: read instructions (warnings) carefully		WEEE disposal
	Keep in a cool, dry place		Keep away from sunlight
	Manufacturer		Date of manufacture
	Product code		Lot number
	Medical Device compliant with Regulation (EU) 2017/745		Consult instructions for use
	Follow instructions for use		Medical device
	Type BF applied part		

 **Disposal:** *The product must not be disposed of along with other domestic waste. The users must dispose of this equipment by bringing it to a specific recycling point for electric and electronic equipment.*

**GIMA WARRANTY TERMS**

The Gima 12-month standard B2B warranty applies.